

Spanner Wrenches

Adjustable Face Spanner

Extreme Capacity	Diameter of Pin	Length of Pin	Overall Length	Wt. Ea. Lbs.	Industrial Black	Std. Pkg. Qty.
	A	B	C		Part No.	
2	$\frac{3}{16}$	$\frac{1}{4}$	$6\frac{3}{8}$.31	482	6
3	$\frac{1}{4}$	$\frac{1}{4}$	$8\frac{1}{4}$.52	483	6
4	$\frac{5}{16}$	$\frac{1}{2}$	$10\frac{1}{2}$	1.02	484	6



Pin Spanner

For Circle Diameter	Diameter of Pin	Length of Pin	Overall Length	Wt. Ea. Lbs.	Industrial Black	Std. Pkg. Qty.
	A	B	C			
1	$\frac{3}{16}$	$\frac{3}{16}$	4	.08	452	6
1 1/4	$\frac{13}{64}$	$\frac{3}{16}$	4 1/2	.11	453	6
1 1/2	$\frac{7}{32}$	$\frac{7}{32}$	5	.13	454	6
1 3/4	$\frac{15}{64}$	$\frac{7}{32}$	5 1/2	.17	455	6
2	$\frac{1}{4}$	$\frac{1}{4}$	6	.20	456	6
2 1/4	$\frac{17}{64}$	$\frac{1}{4}$	6 1/2	.24	457	6
2 1/2	$\frac{9}{32}$	$\frac{3}{32}$	7	.28	458	6
2 3/4	$\frac{19}{64}$	$\frac{3}{32}$	7 1/2	.37	459	6
3	$\frac{5}{16}$	$\frac{3}{16}$	8	.43	460	6
3 1/4	$\frac{21}{64}$	$\frac{3}{16}$	8 1/2	.47	461	6
3 1/2	$\frac{11}{32}$	$\frac{5}{16}$	9	.50	462	6
3 3/4	$\frac{23}{64}$	$\frac{3}{8}$	9 1/2	.59	463	6
4	$\frac{3}{8}$	$\frac{7}{16}$	10	.69	464	6
5	$\frac{7}{16}$	$\frac{7}{16}$	12	1.15	466	6
6	$\frac{1}{2}$	$\frac{1}{2}$	14	1.90	468	6



Face Spanner

Center Distance of Pins	Pins		Span of Jaws in Clear	Length from Center of Pins	Thick-ness	Wt. Ea. Lbs.	Industrial Black	Std. Pkg. Qty.
	Dia.	Length					Part No.	
A	B	C	D	E	F			
1	$\frac{3}{16}$	$\frac{3}{16}$	$1\frac{1}{16}$	$4\frac{1}{2}$	$\frac{3}{16}$.12	418	6
1 1/4	$\frac{7}{32}$	$\frac{7}{32}$	$\frac{7}{8}$	5	$\frac{3}{16}$.13	420	6
1 1/2	$\frac{7}{32}$	$\frac{7}{32}$	$1\frac{1}{8}$	$5\frac{1}{2}$	$\frac{3}{16}$.23	422	6
1 3/4	$\frac{7}{32}$	$\frac{7}{32}$	$1\frac{3}{8}$	6	$\frac{7}{32}$.30	424	6
2	$\frac{1}{4}$	$\frac{1}{4}$	$1\frac{19}{32}$	$6\frac{1}{2}$	$\frac{7}{32}$.39	426	6
2 1/4	$\frac{1}{4}$	$\frac{1}{4}$	$1\frac{27}{32}$	7	$\frac{7}{32}$.42	428	6
2 1/2	$\frac{9}{32}$	$\frac{9}{32}$	$2\frac{1}{32}$	$7\frac{1}{2}$	$\frac{1}{4}$.52	430	6
2 3/4	$\frac{9}{32}$	$\frac{9}{32}$	$2\frac{27}{32}$	8	$\frac{1}{4}$.59	432	6
3	$\frac{5}{16}$	$\frac{5}{16}$	$2\frac{1}{2}$	$8\frac{1}{2}$	$\frac{1}{4}$.70	434	6
3 1/4	$\frac{5}{16}$	$\frac{5}{16}$	$2\frac{3}{4}$	$9\frac{1}{8}$	$\frac{1}{4}$.82	436	6
3 1/2	$\frac{5}{16}$	$\frac{5}{16}$	3	$9\frac{3}{4}$	$\frac{1}{4}$.89	438	6
3 3/4	$\frac{3}{8}$	$\frac{3}{8}$	$3\frac{3}{16}$	$10\frac{3}{8}$	$\frac{1}{4}$	1.0	440	6
4	$\frac{3}{8}$	$\frac{3}{8}$	$3\frac{1}{16}$	11	$\frac{1}{4}$	1.1	442	6

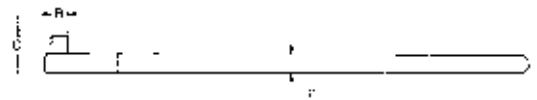



Spanner Wrenches

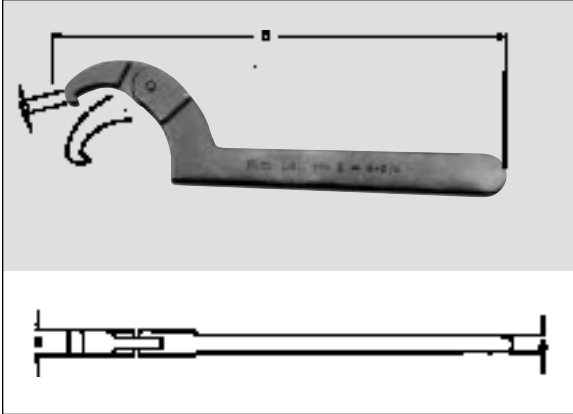

Adjustable Hook Spanner

Capacity Range	Thickness of Handle	Thickness of Hook	Depth of Hook	Length	Wt. Ea. Lbs.	Industrial Black	Std. Pkg. Qty.
	A	B	C	D		Part No.	
3/4 to 2	1/4	1 1/2	1/8	6 3/8	.23	471	6
1 1/4 to 3	3/32	1 3/32	5/32	8 1/8	.43	472	6
2 to 4 1/4	3/16	1 9/32	3/16	11 3/8	1.03	474	6
4 1/2 to 6 1/4	3/16	1 9/32	1/4	12 1/2	1.07	474A	6
6 1/2 to 8 3/4	5/16	1 5/32	5/16	13 3/4	1.40	474B	6

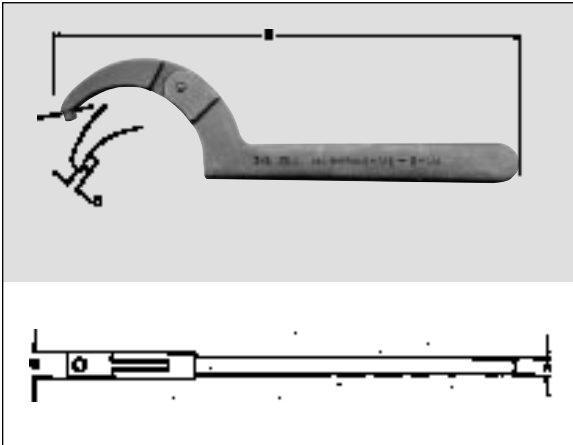

Adjustable Pin Spanner

Capacity Range	Thickness		Pin Size		Overall Length	Wt. Ea. Lbs.	Industrial Black	Std. Pkg. Qty.
	Handle	Hook	Diameter	Length			Part No.	
	A	B	C	D	E			
3/4 to 2	1/4	1 1/2	1/8	1/8	6 3/8	.23	0471	6
3/4 to 2	1/4	1 1/2	3/16	5/32	6 3/8	.23	0471A	6
1 1/4 to 3	3/32	1 3/32	3/16	3/16	8 1/8	.42	0472	6
1 1/4 to 3	3/32	1 3/32	1/4	7/32	8 1/8	.42	0472A	6
2 to 4 1/4	3/16	1 9/32	1/4	1/4	11 3/8	.99	0474	6
4 1/2 to 6 1/4	5/16	1 5/32	3/8	1/4	12 1/2	1.08	0474A	6

Adjustable Pin Spanner Wrench Set

SPW6K



Capacity Range	Pin Diam.	Part No.
3/4 to 2	1/8	0471
3/4 to 2	3/16	0471A
1 1/4 to 3	3/16	0472
1 1/4 to 3	1/4	0472A
2 to 4 1/4	1/4	0474
4 1/2 to 6 1/4	3/8	0474A
Kit Bag		C60B