

Type A

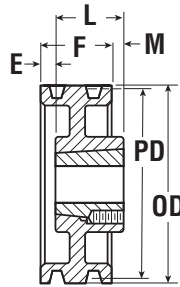

Type B

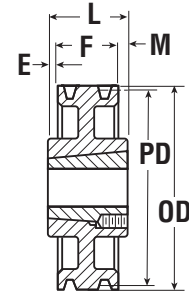

Type C



1 = Solid

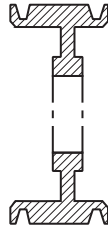

2 = Web

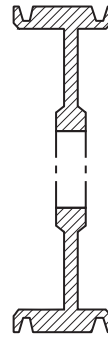

3 = Arm/Spoke



3/8 x 5/16

3V

Taper Bushed Sheaves – 3V

1 Groove F = 11/16 *										2 Grooves F = 1 3/32							
Part Number	Diameter		Type	Bush	Bush Max Bore	E	L Length Thru Bore	M	Wt. Less Bush	Part Number	Type	Bush	Bush Max Bore	E	L Length Thru Bore	M	Wt. Less Bush
	OD	Pitch 3V															
1 3V 265 TB	2.65	2.65	A-1	1108	1.125	0.21875	0.875	–	0.8	2 3V 265 TB	A-1	1108	1.125	0.21875	0.875	–	0.8
1 3V 280 TB	2.8	2.8	A-1	1108	1.125	0.21875	0.875	–	0.9	2 3V 280 TB	A-1	1108	1.125	0.21875	0.875	–	0.9
1 3V 300 TB	3	3	A-1	1108	1.125	0.21875	0.875	–	1.0	2 3V 300 TB	A-1	1210	1.25	0.5	1	–	1.4
1 3V 315 TB	3.15	3.15	A-1	1108	1.125	0.21875	0.875	–	1.3	2 3V 315 TB	A-1	1210	1.25	0.5	1	–	1.6
1 3V 335 TB	3.35	3.35	A-1	1610	1.625	–	1	–	1.5	2 3V 335 TB	A-1	1610	1.625	0.5	1	–	1.7
1 3V 365 TB	3.65	3.65	A-1	1610	1.625	–	1	–	2.0	2 3V 365 TB	A-1	1610	1.625	0.5	1.5	–	2.0
1 3V 412 TB	4.12	4.12	B-1	1610	1.625	–	1	0.40625	2.3	2 3V 412 TB	A-1	1610	1.625	–	1	–	2.1
1 3V 450 TB	4.5	4.5	B-1	1610	1.625	–	1	0.40625	3.0	2 3V 450 TB	A-1	1610	1.625	–	1	–	2.7
1 3V 475 TB	4.75	4.75	B-1	1610	1.625	–	1	0.40625	3.3	2 3V 475 TB	A-1	1610	1.625	–	1	–	3.0
1 3V 500 TB	5	5	B-1	1610	1.625	–	1	0.40625	3.5	2 3V 500 TB	A-1	1610	1.625	–	1	–	4.0
1 3V 530 TB	5.3	5.3	B-1	1610	1.625	–	1	0.40625	3.8	2 3V 530 TB	A-1	1610	1.625	–	1	–	5.0
1 3V 560 TB	5.6	5.6	B-1	1610	1.625	–	1	0.40625	4.0	2 3V 560 TB	A-1	1610	1.625	–	1	–	6.0
1 3V 600 TB	6	6	B-1	1610	1.625	–	1	0.40625	5.0	2 3V 600 TB	A-1	1610	1.625	–	1	–	7.0
1 3V 650 TB	6.5	6.5	B-1	1610	1.625	–	1	0.40625	6.0	2 3V 650 TB	A-1	1610	1.625	–	1	–	8.0
1 3V 690 TB	6.9	6.9	B-1	1610	1.625	–	1	0.40625	7.0	2 3V 690 TB	A-1	1610	1.625	–	1	–	9.0
1 3V 800 TB	8	8	B-2	2517	2.5	–	1.75	1.0625	9.0	2 3V 800 TB	B-2	2517	2.5	–	1.75	0.65625	10.0
1 3V 1060 TB	10.6	10.6	B-2	2517	2.5	–	1.75	1.0625	13.0	2 3V 1060 TB	B-2	2517	2.5	–	1.75	0.65625	14.0
1 3V 1400 TB*	14	14	B-3	2517	2.5	–	1.75	0.9375	15.0	2 3V 1400 TB	B-3	2517	2.5	–	1.75	0.65625	18.0
1 3V 1900 TB*	19	19	B-3	3020	3	–	2	1.1875	27.0	2 3V 1900 TB	B-3	3020	3	–	2	0.65625	32.0
–	25	25	–	–	–	–	–	–	–	2 3V 2500 TB	C-3	3020	3	0.125	2	0.65625	45.0

* F= 11/16" thru 1 3V 1400 TB

F= 13/16" thru 1 3V 1400 TB and 1 3V 1900 TB

3V Hi-Cap Wedge Stock Taper Bushed Sheaves

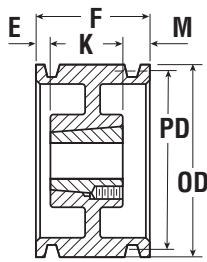

Type A

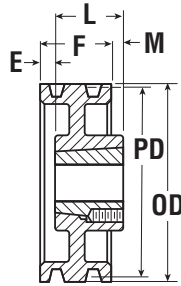

Type B

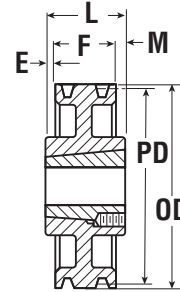

Type C



1 = Solid

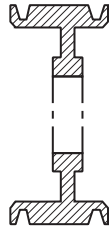

2 = Web

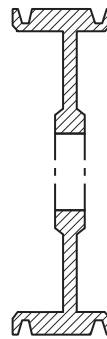

3 = Arm/Spoke



$\frac{3}{8} \times \frac{5}{16}$

3V

Taper Bushed Sheaves – 3V

3 Grooves										4 Grooves							
F = 1 1/2										F = 1 29/32							
Part Number	Diameter		Type	Bush	Bush Max Bore	E	L Length Thru Bore	M	Wt. Less Bush	Part Number	Type	Bush	Bush Max Bore	E	L Length Thru Bore	M	Wt. Less Bush
	OD	Pitch 3V															
3 3V 265 TB	2.65	2.6	A-1	1108	1.125	.625	.875	–	1.0	4 3V 265 TB	A-1	1108	1.125	1.0313	.875	–	1.2
3 3V 280 TB	2.8	2.75	A-1	1108	1.125	.625	.875	–	1.1	4 3V 280 TB	A-1	1108	1.125	1.0313	.875	–	1.3
3 3V 300 TB	3	2.95	A-1	1210	1.25	.9063	1	–	1.8	4 3V 300 TB	A-1	1210	1.25	1.3125	1	–	2.1
3 3V 315 TB	3.15	3.1	A-1	1210	1.25	.9063	1	–	2.0	4 3V 315 TB	A-1	1210	1.25	1.3125	1	–	2.2
3 3V 335 TB	3.35	3.3	A-1	1610	1.625	.9063	1	–	2.3	4 3V 335 TB	A-1	1610	1.625	1.3125	1	–	2.4
3 3V 365 TB	3.65	3.6	A-1	1610	1.625	.9063	1	–	2.6	4 3V 365 TB	A-1	1610	1.625	.9063	1	–	2.8
3 3V 412 TB	4.12	4.07	A-1	1610	1.625	.5	1	–	3.0	4 3V 412 TB	A-1	1610	1.625	.9063	1	–	3.0
3 3V 450 TB	4.5	4.45	A-1	1610	1.625	.5	1	–	3.2	4 3V 450 TB	A-1	1610	1.625	.9063	1	–	4.0
3 3V 475 TB	4.75	4.7	A-1	1610	1.625	.5	1	–	4.0	4 3V 475 TB	A-1	1610	1.625	.9063	1	–	5.0
3 3V 500 TB	5	4.95	A-1	1610	1.625	.5	1	–	4.5	4 3V 500 TB	A-1	1610	1.625	.9063	1	–	5.5
3 3V 530 TB	5.3	5.25	A-1	1610	1.625	.5	1	–	5.0	4 3V 530 TB	A-1	1610	1.625	.9063	1	–	6.0
3 3V 560 TB	5.6	5.55	A-1	1610	1.625	.5	1	–	6.0	4 3V 560 TB	A-1	1610	1.625	.9063	1	–	7.0
3 3V 600 TB	6.0	5.95	B-1	2517	2.5	.1563	1.75	.4063	7.0	4 3V 600 TB	A-1	2517	2.5	.1563	1.75	–	8.0
3 3V 650 TB	6.5	6.45	B-1	2517	2.5	.1563	1.75	.4063	9.0	4 3V 650 TB	A-1	2517	2.5	.1563	1.75	–	10.0
3 3V 690 TB	6.9	6.85	B-1	2517	2.5	.1563	1.75	.4063	10.0	4 3V 690 TB	A-1	2517	2.5	.1563	1.75	–	12.0
3 3V 800 TB	8	7.95	B-1	2517	2.5	.1563	1.75	.4063	15.0	4 3V 800 TB	A-1	2517	2.5	.1563	1.75	–	18.0
3 3V 1060 TB	10.6	10.55	B-2	2517	2.5	–	1.75	.25	18.0	4 3V 1060 TB	A-2	2517	2.5	.1563	1.75	–	19.0
3 3V 1400 TB	14	13.95	B-3	2517	2.5	–	1.75	.25	20.0	4 3V 1400 TB	A-3	2517	2.5	–	1.75	0.1563	22.0
3 3V 1900 TB	19	18.95	B-3	3020	3	–	2	.5	36.0	4 3V 1900 TB	C-3	3020	3	–	2	0.0938	45.0
3 3V 2500 TB	25	24.95	B-3	3020	3	–	2	.5	47.0	4 3V 2500 TB	C-3	3020	3	–	2	0.0938	63.0
3 3V 3350 TB	33.5	33.45	B-3	3020	3	.2500	2	.25	76.0	4 3V 3350 TB	C-3	3030	3	.5469	3	0.5469	80.0

Dimensions in inches, weight in pounds. Weights do not include bushings. See page B-8 thru B-10 for additional bushing dimensions.

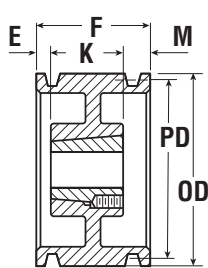

Type A

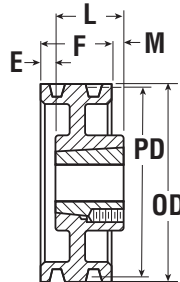

Type B

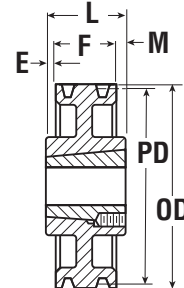

Type C

Taper Bushed Sheaves – 3V

5 Grooves										6 Grooves							
F = 2 ^{5/16}										F = 2 ^{23/32}							
Part Number	Diameter		Type	Bush	Bush Max Bore	E	L Length Thru Bore	M	Wt. Less Bush	Part Number	Type	Bush	Bush Max Bore	E	L Length Thru Bore	M	Wt. Less Bush
	OD	Pitch 3V															
5 3V 450 TB	4.50	4.50	A-1	1615	1.63	—	1.5	.8125	4.0	—	—	—	—	—	—	—	—
5 3V 475 TB	4.75	4.75	A-1	2517	2.5	.5625	1.75	—	4.0	6 3V 475 TB	A-1	2517	2.5	.9688	1.75	—	4.4
5 3V 500 TB	5.00	5.00	A-1	2517	2.5	.5625	1.75	—	4.8	6 3V 500 TB	A-1	2517	2.5	.9688	1.75	—	5.4
5 3V 530 TB	5.30	5.30	A-1	2517	2.5	.5625	1.75	—	5.9	6 3V 530 TB	A-1	2517	2.5	.9688	1.75	—	6.5
5 3V 560 TB	5.60	5.60	A-1	2517	2.5	.5625	1.75	—	7.0	6 3V 560 TB	A-1	2517	2.5	.9688	1.75	—	7.7
5 3V 600 TB	6.00	6.00	A-1	2517	2.5	.5625	1.75	—	8.0	6 3V 600 TB	A-1	2517	2.5	.9688	1.75	—	9.5
5 3V 650 TB	6.50	6.50	A-1	2517	2.5	.5625	1.75	—	11.0	6 3V 650 TB	A-1	2517	2.5	.9688	1.75	—	12.0
5 3V 690 TB	6.90	6.90	A-1	2517	2.5	.5625	1.75	—	13.0	6 3V 690 TB	A-1	2517	2.5	.9688	1.75	—	13.0
5 3V 800 TB	8.00	8.00	A-1	2517	2.5	.5625	1.75	—	19.0	6 3V 800 TB	A-1	2517	2.5	.9688	1.75	—	2.0
5 3V 1060 TB	10.60	10.60	A-2	2517	2.5	.5625	1.75	—	21.0	6 3V 1060 TB	A-2	2517	2.5	.9688	1.75	—	21.0
5 3V 1400 TB	14.00	14.00	A-3	2517	2.5	—	1.75	.5625	3.0	6 3V 1400 TB	A-3	2517	2.5	.2188	1.75	—	3.0
5 3V 1900 TB	19.00	19.00	A-3	3030	3	—	2	.3125	51.0	6 3V 1900 TB	B-3	3020	3	—	2	.7188	51.0
5 3V 2500 TB	25.00	25.00	B-3	3030	3	—	3	.6875	76.0	6 3V 2500 TB	B-3	3030	3	—	3	.2813	81.0
5 3V 3350 TB	33.50	33.50	C-3	3030	3	.3438	3	.3438	97.0	6 3V 3350 TB	C-3	3030	3	.1406	3	.1406	11.0

8 Grooves										10 Grooves							
F = 3 ^{17/32}										F = 4 ^{11/32}							
Part Number	Diameter		Type	Bush	Bush Max Bore	E	L Length Thru Bore	M	Wt. Less Bush	Part Number	Type	Bush	Bush Max Bore	E	L Length Thru Bore	M	Wt. Less Bush
	OD	Pitch 3V															
8 3V 475 TB	4.75	4.75	A-1	2517	2.5	1.78	1.75	—	5.0	10 3V 475 TB	A-1	2517	2.5	2.5938	1.75	—	6.0
8 3V 5 TB	5	5	A-1	2517	2.5	1.78	1.75	—	6.0	10 3V 5 TB	A-1	2517	2.5	2.5938	1.75	—	7.0
8 3V 530 TB	5.3	5.3	A-1	2517	2.5	1.03	1.75	.75	7.8	10 3V 530 TB	A-1	2517	2.5	1.8438	1.75	.75	8.0
8 3V 560 TB	5.6	5.6	A-1	2517	2.5	.25	1.75	1.5313	9.0	10 3V 560 TB	A-1	2517	2.5	.5	1.75	.7188	9.0
8 3V 6 TB	6	6	A-1	2517	2.5	.25	1.75	1.5313	11.0	10 3V 6 TB	A-1	2517	2.5	.5	1.75	.7188	12.0
8 3V 650 TB	6.5	6.5	A-1	2517	2.5	.25	1.75	1.5313	13.0	10 3V 650 TB	A-1	2517	2.5	.5	1.75	.7188	14.0
8 3V 690 TB	6.9	6.9	A-1	2517	2.5	.25	1.75	1.5313	15.0	10 3V 690 TB	A-1	2517	2.5	.5	1.75	.7188	17.0
8 3V 8 TB	8	8	A-1	3020	3	.5	2	1.0313	19.0	10 3V 8 TB	A-1	3020	3	.25	2	.7188	22.0
8 3V 1060 TB	10.6	10.6	A-2	3020	3	.5	2	1.0313	26.0	10 3V 1060 TB	A-2	3020	3	.8438	2	1.5	32.0
8 3V 14 TB	14	14	A-3	3020	3	.6563	2	0.875	52.0	10 3V 14 TB	A-2	3535	3.5	—	3.5	.8438	59.0
8 3V 19 TB	19	19	A-3	3535	3.5	—	3.5	0.0313	63.0	10 3V 19 TB	A-3	3535	3.5	—	3.5	.8438	71.0
8 3V 25 TB	25	25	A-3	3535	3.5	—	3.5	0.0313	89.0	10 3V 25 TB	A-3	4040	4	—	4	.3438	121.0
8 3V 3350 TB	33.5	33.5	C-3	4040	4	.2344	4	0.2344	131.0	10 3V 3350 TB	A-3	4040	4	.1719	4	.3438	172.0

5V Hi-Cap Wedge Stock Taper Bushed Sheaves

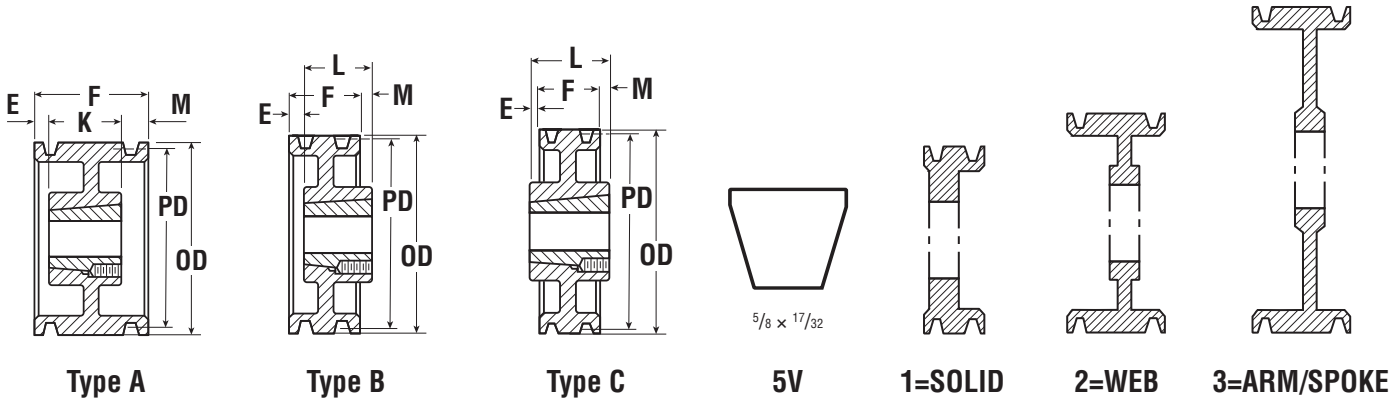

Taper Bushed Sheaves – 5V

2 Grooves										3 Grooves							
F = 1 11/16										F = 2 3/8							
Part Number	Diameter		Type	Bush	Bush Max Bore	E	L Length Thru Bore	M	Wt. Less Bush	Part Number	Type	Bush	Bush Max Bore	E	L Length Thru Bore	M	Wt. Less Bush
	OD	Pitch 5V															
*2 5V 440 TB	4.4	4.4	A-1	1610	1.625	.0625	1	.625	3.0	*3 5V 440 TB	A-1	1610	1.625	1.375	1	–	4.0
*2 5V 465 TB	4.65	4.65	A-1	1610	1.625	.0625	1	.625	3.0	*3 5V 465 TB	A-1	1610	1.625	.0625	1	1.3125	5.0
*2 5V 490 TB	4.9	4.9	A-1	1610	1.625	.0625	1	.625	4.0	*3 5V 490 TB	A-1	1610	1.625	.0625	1	1.3125	5.0
*2 5V 520 TB	5.2	5.2	A-1	1610	1.625	.0625	1	.625	4.2	*3 5V 520 TB	A-1	1610	1.625	.0625	1	1.3125	6.0
*2 5V 550 TB	5.5	5.5	A-1	1610	1.625	.0625	1	.625	5.2	*3 5V 550 TB	A-1	1610	1.625	.0625	1	1.3125	6.0
*2 5V 590 TB	5.9	5.9	A-1	1610	1.625	.0625	1	.625	5.6	*3 5V 590 TB	A-1	2517	2.5	–	1.75	.625	7.0
*2 5V 630 TB	6.3	6.3	A-1	1610	1.625	–	1	.6875	7.6	*3 5V 630 TB	A-1	2517	2.5	–	1.75	.625	9.0
*2 5V 670 TB	6.7	6.7	A-1	1610	1.625	–	1	.6875	9.4	*3 5V 670 TB	A-1	2517	2.5	–	1.75	.625	10.0
2 5V 710 TB	7.1	7.1	B-1	2517	2.5	.0625	1.75	–	10.0	3 5V 710 TB	A-1	2517	2.5	.625	1.75	–	11.0
2 5V 750 TB	7.5	7.5	B-1	2517	2.5	.0625	1.75	–	13.0	3 5V 750 TB	A-1	2517	2.5	.625	1.75	–	14.0
2 5V 800 TB	8	8	B-1	2517	2.5	.0625	1.75	–	14.0	3 5V 800 TB	A-1	2517	2.5	.625	1.75	–	16.0
2 5V 850 TB	8.5	8.5	B-2	2517	2.5	.0625	1.75	–	15.0	3 5V 850 TB	A-2	2517	2.5	.625	1.75	–	17.0
2 5V 900 TB	9	9	B-2	2517	2.5	.0625	1.75	–	16.0	3 5V 900 TB	A-2	2517	2.5	.625	1.75	–	19.0
2 5V 925 TB	9.25	9.25	B-2	3020	3	–	2	.3125	17.0	3 5V 925 TB	A-1	3020	3	–	2	.375	23.0
2 5V 975 TB	9.75	9.75	B-2	3020	3	–	2	.3125	18.0	3 5V 975 TB	A-1	3020	3	–	2	.375	24.0
2 5V 1030 TB	10.3	10.3	B-2	3020	3	–	2	.3125	20.0	3 5V 1030 TB	A-2	3020	3	–	2	.375	27.0
2 5V 1090 TB	10.9	10.9	B-2	3020	3	–	2	.3125	22.0	3 5V 1090 TB	A-2	3020	3	–	2	.375	28.0
2 5V 1130 TB	11.3	11.3	B-2	3020	3	–	2	.3125	25.0	3 5V 1130 TB	A-2	3020	3	–	2	.375	30.0
2 5V 1180 TB	11.8	11.8	B-2	3020	3	–	2	.3125	26.0	3 5V 1180 TB	A-2	3020	3	–	2	.375	32.0
2 5V 1250 TB	12.5	12.5	B-2	3020	3	–	2	.3125	28.0	3 5V 1250 TB	A-2	3020	3	–	2	.375	34.0
2 5V 1320 TB	13.2	13.2	B-3	3020	3	–	2	.3125	29.0	3 5V 1320 TB	A-3	3020	3	–	2	.375	36.0
2 5V 1400 TB	14	14	B-3	3020	3	–	2	.3125	33.0	3 5V 1400 TB	A-3	3020	3	–	2	.375	41.0
2 5V 1500 TB	15	15	B-3	3020	3	–	2	.3125	35.0	3 5V 1500 TB	A-3	3020	3	–	2	.375	50.0
2 5V 1600 TB	16	16	B-3	3020	3	–	2	.3125	45.0	3 5V 1600 TB	A-3	3020	3	–	2	.375	52.0
2 5V 1870 TB	18.7	18.7	C-3	3020	3	–	2	.3125	50.1	3 5V 1870 TB	B-3	3535	3.5	–	3.5	1.125	65.0
2 5V 2120 TB	21.2	21.2	C-3	3535	3.5	.375	3.5	1.4375	60.0	3 5V 2120 TB	C-3	3535	3.5	–	3.5	1.125	68.0
2 5V 2360 TB	23.6	23.6	C-3	3535	3.5	1/4	3.5	1.5625	68.0	3 5V 2360 TB	B-3	3535	3.5	–	3.5	1.125	99.0
2 5V 2800 TB	28	28	C-3	3535	3.5	.375	3.5	1.4375	96.0	3 5V 2800 TB	C-3	3535	3.5	.3438	3.5	25/32	96.0
–	–	–	–	–	–	–	–	–	–	3 5V 3750 TB	C-3	4040	4	.5	4	1.125	172.0
–	–	–	–	–	–	–	–	–	–	3 5V 5000 TB	C-3	4040	4	.5	4	1.125	201.0

Dimensions in inches, weight in pounds. Weights do not include bushings. See page B-8 thru B-10 for additional bushing dimensions.

* 5VX Belts only on these sizes.

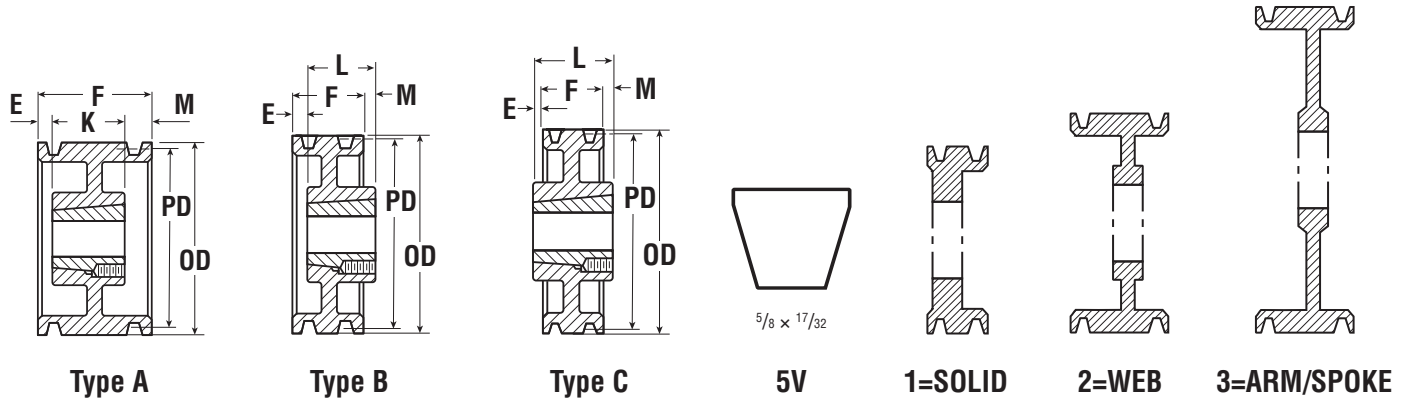

Taper Bushed Sheaves – 5V

4 Grooves										5 Grooves							
F = 3 1/16										F = 3 3/4							
Part Number	Diameter		Type	Bush	Bush Max Bore	E	L Length Thru Bore	M	Wt. Less Bush	Part Number	Type	Bush	Bush Max Bore	E	L Length Thru Bore	M	Wt. Less Bush
	OD	Pitch 5V															
*4 5V 440 TB	4.4	4.4	A-1	1610	1.625	2.0625	1	-	6.0	-	-	-	-	-	-	-	-
*4 5V 465 TB	4.65	4.65	A-1	1610	1.625	2.0625	1	-	6.0	-	-	-	-	-	-	-	-
*4 5V 490 TB	4.9	4.9	A-1	1610	1.625	2.0625	1	-	6.0	-	-	-	-	-	-	-	-
*4 5V 520 TB	5.2	5.2	A-1	1610	1.625	2.0625	1	-	7.0	-	-	-	-	-	-	-	-
*4 5V 550 TB	5.5	5.5	A-1	2517	2.5	1.3125	1.75	-	8.0	-	-	-	-	-	-	-	-
*4 5V 590 TB	5.9	5.9	A-1	2517	2.5	1.3125	1.75	-	10.0	*5 5V 590 TB	A-1	2517	2.5	.5625	1.75	1.4375	11.0
*4 5V 630 TB	6.3	6.3	A-1	2517	2.5	-	1.75	1.3125	11.0	*5 5V 630 TB	A-1	2517	2.5	.5625	1.75	1.4375	12.0
*4 5V 670 TB	6.7	6.7	A-1	2517	2.5	-	1.75	1.3125	12.0	*5 5V 670 TB	A-1	2517	2.5	.5625	1.75	1.4375	13.0
4 5V 710 TB	7.1	7.1	A-1	2517	2.5	1.3125	1.75	-	14.0	5 5V 710 TB	A-1	3020	3	.5	2	1.25	15.0
4 5V 750 TB	7.5	7.5	A-1	2517	2.5	1.3125	1.75	-	16.0	5 5V 750 TB	A-1	3020	3	.5	2	1.25	17.0
4 5V 800 TB	8	8	A-1	2517	2.5	1.3125	1.75	-	17.0	5 5V 800 TB	A-1	3020	3	.5	2	1.25	20.0
4 5V 850 TB	8.5	8.5	A-2	2517	2.5	1.3125	1.75	-	18.0	5 5V 850 TB	A-1	3020	3	.5	2	1.25	22.0
4 5V 900 TB	9	9	A-2	2517	2.5	1.3125	1.75	-	19.0	5 5V 900 TB	A-1	3020	3	.5	2	1.25	30.0
4 5V 925 TB	9.25	9.25	A-1	3020	3	.5	2	.5625	22.0	5 5V 925 TB	A-1	3020	3	.5	2	1.25	36.0
4 5V 975 TB	9.75	9.75	A-1	3020	3	.5	2	.5625	27.0	5 5V 975 TB	A-1	3020	3	.5	2	1.25	37.0
4 5V 1030 TB	10.3	10.3	A-2	3020	3	.5	2	.5625	28.0	5 5V 1030 TB	A-2	3020	3	.5	2	1.25	38.0
4 5V 1090 TB	10.9	10.9	A-2	3020	3	.5	2	.5625	31.0	5 5V 1090 TB	A-2	3020	3	.5	2	1.25	39.0
4 5V 1130 TB	11.3	11.3	A-1	3020	3	-	2	1.0625	32.0	5 5V 1130 TB	A-1	3020	3	.5	2	1.25	38.0
4 5V 1180 TB	11.8	11.8	A-2	3020	3	.5	2	.5625	35.0	5 5V 1180 TB	A-2	3020	3	.5	2	1.25	40.0
4 5V 1250 TB	12.5	12.5	A-2	3020	3	-	2	1.0625	44.0	5 5V 1250 TB	A-2	3535	3.5	-	3.5	.25	50.0
4 5V 1320 TB	13.2	13.2	A-3	3020	3	-	2	1.0625	42.0	5 5V 1320 TB	A-2	3535	3.5	-	3.5	.25	56.0
4 5V 1400 TB	14	14	B-3	3535	3.5	-	3.5	.4375	53.0	5 5V 1400 TB	A-3	3535	3.5	-	3.5	.25	58.0
4 5V 1500 TB	15	15	B-3	3535	3.5	-	3.5	.4375	54.0	5 5V 1500 TB	A-3	3535	3.5	-	3.5	.25	65.0
4 5V 1600 TB	16	16	B-3	3535	3.5	-	3.5	.4375	60.0	5 5V 1600 TB	A-3	3535	3.5	-	3.5	.25	70.0
4 5V 1870 TB	18.7	18.7	C-3	3535	3.5	.4375	3.5	-	63.0	5 5V 1870 TB	A-3	3535	3.5	-	3.5	.25	84.0
4 5V 2120 TB	21.2	21.2	B-3	3535	3.5	-	3.5	.4375	72.0	5 5V 2120 TB	B-3	4040	4	-	4	.25	115.0
4 5V 2360 TB	23.6	23.6	C-3	3535	3.5	-	3.5	.4375	79.0	5 5V 2360 TB	C-3	4040	4	-	4	.25	92.0
4 5V 2800 TB	28	28	B-3	3535	3.5	-	3.5	.4375	125.0	5 5V 2800 TB	B-3	4040	4	-	4	.25	160.0
4 5V 3150 TB	31.5	31.5	C-3	3535	3.5	-	3.5	.4375	114.0	5 5V 3150 TB	A-3	4040	4	-	4	.25	155.0
4 5V 3750 TB	37.5	37.5	B-3	4040	4	-	4	.9375	189.0	5 5V 3750 TB	B-3	4040	4	-	4	.25	182.0
4 5V 5000 TB	50	50	B-3	4040	4	-	4	.9375	371.0	5 5V 5000 TB	B-3	4545	4.5	-	4.5	.75	288.0

Dimensions in inches, weight in pounds. Weights do not include bushings. See page B-8 thru B-10 for additional bushing dimensions.

* 5VX Belts only on these sizes.

5V Hi-Cap Wedge Stock Taper Bushed Sheaves



6 Grooves										8 Grooves							
F = 4 7/16										F = 5 13/16							
Part Number	Diameter		Type	Bush	Bush Max Bore	E	L LTB	M	Wt. Less Bush	Part Number	Type	Bush	Bush Max Bore	E	L LTB	M	Wt. Less Bush
	OD	Pitch 5V															
*6 5V 590 TB	5.9	5.9	A-1	2517	2.5	1.125	1.75	1.5625	13.0	-	-	-	-	-	-	-	-
*6 5V 630 TB	6.3	6.3	A-1	2517	2.5	.8125	1.75	1.875	13.0	-	-	-	-	-	-	-	-
*6 5V 670 TB	6.7	6.7	A-1	2517	2.5	.8125	1.75	1.875	15.0	-	-	-	-	-	-	-	-
6 5V 710 TB	7.1	7.1	A-1	3020	3	.75	2	1.6875	17.0	8 5V 710 TB	A-1	3030	3	1	3	1.8125	24.0
6 5V 750 TB	7.5	7.5	A-1	3020	3	.75	2	1.6875	20.0	8 5V 750 TB	A-1	3030	3	1	3	1.8125	27.0
6 5V 800 TB	8	8	A-1	3020	3	.75	2	1.6875	24.0	8 5V 800 TB	A-1	3030	3	1	3	1.8125	33.0
6 5V 850 TB	8.5	8.5	A-1	3020	3	.75	2	1.6875	28.0	8 5V 850 TB	A-1	3030	3	1	3	1.8125	39.0
6 5V 900 TB	9	9	A-1	3020	3	.75	2	1.6875	32.0	8 5V 900 TB	A-1	3535	3.5	1	3.5	1.3125	44.0
6 5V 925 TB	9.25	9.25	A-1	3535	3.5	-	3.5	.9375	39.0	8 5V 925 TB	A-1	3535	3.5	1	3.5	1.3125	48.0
6 5V 975 TB	9.75	9.75	A-1	3535	3.5	-	3.5	.9375	50.0	8 5V 975 TB	A-1	3535	3.5	1	3.5	1.3125	55.0
6 5V 1030 TB	10.3	10.3	A-1	3535	3.5	-	3.5	.9375	58.0	8 5V 1030 TB	A-1	3535	3.5	1	3.5	1.3125	64.0
6 5V 1090 TB	10.9	10.9	A-1	3535	3.5	-	3.5	.9375	60.0	8 5V 1090 TB	A-1	3535	3.5	1	3.5	1.3125	68.0
-	11.3	11.3	-	-	-	-	-	-	-	8 5V 1130 TB	A-1	3535	3.5	1	3.5	1.3125	57.0
6 5V 1180 TB	11.8	11.8	A-2	3535	3.5	-	3.5	.9375	62.0	8 5V 1180 TB	A-1	3535	3.5	1	3.5	1.3125	74.0
6 5V 1250 TB	12.5	12.5	A-2	3535	3.5	-	3.5	.9375	65.0	8 5V 1250 TB	A-1	4040	4	.25	4	1.5625	82.0
6 5V 1320 TB	13.2	13.2	A-2	3535	3.5	-	3.5	.9375	68.0	8 5V 1320 TB	A-1	4040	4	.25	4	1.5625	87.0
6 5V 1400 TB	14	14	A-2	3535	3.5	-	3.5	.9375	72.0	8 5V 1400 TB	A-2	4040	4	.25	4	1.5625	90.0
6 5V 1500 TB	15	15	A-2	4040	4	-	4	.4375	91.0	8 5V 1500 TB	A-2	4040	4	.25	4	1.5625	97.0
6 5V 1600 TB	16	16	A-3	4040	4	-	4	.4375	97.0	8 5V 1600 TB	A-3	4040	4	.25	4	1.5625	106.0
6 5V 1870 TB	18.7	18.7	A-2	4040	4	-	4	.4375	97.0	8 5V 1870 TB	A-3	4040	4	.25	4	1.5625	112.0
6 5V 2120 TB	21.2	21.2	A-3	4040	4	-	4	.4375	123.0	8 5V 2120 TB	A-3	4040	4	.25	4	1.5625	144.0
6 5V 2360 TB	23.6	23.6	A-3	4040	4	-	4	.4375	124.0	8 5V 2360 TB	A-3	4040	4	.25	4	1.5625	145.0
6 5V 2800 TB	28	28	A-3	4040	4	-	4	.4375	176.0	8 5V 2800 TB	A-3	4545	4.5	.25	4.5	1.0625	206.0
6 5V 3150 TB	31.5	31.5	A-3	4040	4	-	4	.4375	171.0	8 5V 3150 TB	A-3	4545	4.5	.25	4.5	1.0625	228.0
6 5V 3750 TB	37.5	37.5	B-3	4545	4.5	-	4.5	.0625	254.0	8 5V 3750 TB	A-3	4545	4.5	.25	4.5	1.0625	271.0
6 5V 5000 TB	50	50	B-3	4545	4.5	-	4.5	.0625	386.0	8 5V 5000 TB	A-3	4545	4.5	.25	4.5	1.0625	458.0

10 Grooves									
F = 7 3/16									
Part Number	Diameter		Type	Bush	Bush Max Bore	E	L LTB	M	Wt. Less Bush
	OD	Pitch 5V							
10 5V 800 TB	8	8	A-1	3030	3	1	3	3.1875	36.0
10 5V 850 TB	8.5	8.5	A-1	3030	3	1	3	3.1875	42.0
10 5V 900 TB	9	9	A-1	3535	3.5	1	3.5	2.6575	47.0
10 5V 925 TB	9.25	9.25	A-1	4040	4	1	4	2.1875	50.0
10 5V 975 TB	9.75	9.75	A-1	4040	4	1	4	2.1875	58.0
10 5V 1030 TB	10.3	10.3	A-1	4040	4	1	4	2.1875	69.0
10 5V 1090 TB	10.9	10.9	A-1	4040	4	1	4	2.1875	79.0
10 5V 1130 TB	11.3	11.3	A-1	4040	4	1	4	2.1875	80.0
10 5V 1180 TB	11.8	11.8	A-1	4040	4	1	4	2.1875	96.0
10 5V 1250 TB	12.5	12.5	A-2	4040	4	.75	4	2.4375	116.0
10 5V 1320 TB	13.2	13.2	A-2	4040	4	.75	4	2.4375	130.0
10 5V 1400 TB	14	14	A-2	4545	4.5	.75	4.5	1.9375	150.0
10 5V 1500 TB	15	15	A-2	4545	4.5	.75	4.5	1.9375	155.0
10 5V 1600 TB	16	16	A-2	4545	4.5	.75	4.5	1.9375	160.0
10 5V 1870 TB	18.7	18.7	A-2	4545	4.5	.5	4.5	2.1875	116.0
10 5V 2120 TB	21.2	21.2	A-3	4545	4.5	.75	4.5	1.9375	210.0
10 5V 2360 TB	23.6	23.6	A-2	4545	4.5	.5	4.5	2.1875	191.0
10 5V 2800 TB	28	28	A-3	4545	4.5	.75	4.5	1.9375	248.0
10 5V 3150 TB	31.5	31.5	A-3	4545	4.5	.75	4.5	1.9375	259.0
10 5V 3750 TB	37.5	37.5	A-3	4545	4.5	.75	4.5	1.9375	375.0
10 5V 5000 TB	50	50	A-3	5050	5	.75	5	1.4375	502.0



5/8 x 17/32

5V

Dimensions in inches, weight in pounds. Weights do not include bushings. See page B-8 thru B-10 for additional bushing dimensions.
* 5VX Belts only on these sizes.

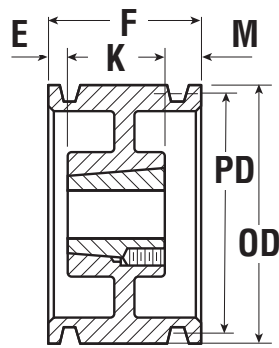

Type A

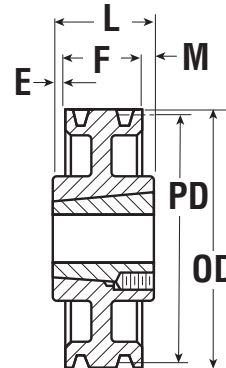

Type C



1=SOLID

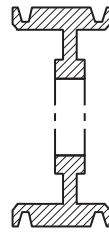

2=WEB

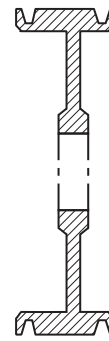

3=ARM/SPOKE

Taper Bushed Sheaves – 8V

4 Grooves F = 4 7/8										5 Grooves F = 6							
Part Number	Diameter		Type	Bush	Bush Max Bore	E	L Length Thru Bore	M	Wt. Less Bush	Part Number	Type	Bush	Bush Max Bore	E	L Length Thru Bore	M	Wt. Less Bush
	OD	Pitch 8V															
4 8V 1250 TB	12.5	12.5	A-1	4040	4	–	4	.875	88.0	5 8V 1250 TB	A-1	4040	4	.1875	4	1.8125	100.0
4 8V 1320 TB	13.2	13.2	A-1	4040	4	–	4	.875	102.0	5 8V 1320 TB	A-1	4040	4	.1875	4	1.8125	115.0
4 8V 1400 TB	14	14	A-1	4040	4	–	4	.875	123.0	5 8V 1400 TB	A-1	4040	4	.1875	4	1.8125	133.0
4 8V 1500 TB	15	15	A-1	4040	4	–	4	.875	145.0	5 8V 1500 TB	A-1	4040	4	.1875	4	1.8125	156.0
4 8V 1600 TB	16	16	A-2	4040	4	–	4	.875	111.0	5 8V 1600 TB	A-1	4040	4	.5	4	1.5	181.0
4 8V 1700 TB	17	17	A-2	4040	4	–	4	.875	120.0	5 8V 1700 TB	A-2	4545	4.5	–	4.5	1.5	146.0
4 8V 1800 TB	18	18	A-2	4040	4	–	4	.875	130.0	5 8V 1800 TB	A-2	4545	4.5	–	4.5	1.5	156.0
4 8V 1900 TB	19	19	A-2	4040	4	–	4	.875	140.0	5 8V 1900 TB	A-2	4545	4.5	–	4.5	1.5	176.0
4 8V 2000 TB	20	20	A-2	4545	4.5	–	4.5	.375	151.0	5 8V 2000 TB	A-2	4545	4.5	–	4.5	1.5	186.0
4 8V 2120 TB	21.2	21.2	A-3	4545	4.5	–	4.5	.375	154.0	5 8V 2120 TB	A-3	4545	4.5	–	4.5	1.5	195.0
4 8V 2240 TB	22.4	22.4	A-3	4545	4.5	–	4.5	.375	185.0	5 8V 2240 TB	A-3	4545	4.5	–	4.5	1.5	200.0
4 8V 2480 TB	24.8	24.8	D-3	5050	5	.9375	5	.8125	191.0	5 8V 2480 TB	A-3	5050	5	–	5	1.5	206.0
4 8V 3000 TB	30	30	C-3	5050	5	–	5	.125	246.0	5 8V 3000 TB	A-3	5050	5	–	5	1	278.0
4 8V 3550 TB	35.5	35.5	D-3	5050	5	1.125	5	1	278.0	5 8V 3550 TB	A-3	5050	5	–	5	1	399.0
4 8V 4000 TB	40	40	B-3	5050	5	–	5	.125	292.0	5 8V 4000 TB	A-3	5050	5	–	5	1	350.0
4 8V 4450 TB	44.5	44.5	D-3	5050	5	.25	5	.125	367.0	5 8V 4450 TB	A-3	5050	5	–	5	1	572.0
4 8V 5300 TB	53	53	B-3	5050	5	–	5	.125	573.0	5 8V 5300 TB	A-3	5050	5	–	5	1	565.0

Dimensions in inches, weight in pounds. Weights do not include bushings. See page B-8 thru B-10 for additional bushing dimensions.

8V Hi-Cap Wedge Stock Taper Bushed Sheaves

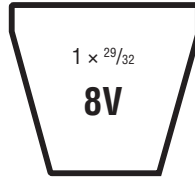

Taper Bushed Sheaves – 8V

6 Grooves F = 7 1/8										8 Grooves F = 9 3/8							
Part Number	Diameter		Type	Bush	Bush Max Bore	E	L Length Thru Bore	M	Wt. Less Bush	Part Number	Type	Bush	Bush Max Bore	E	L Length Thru Bore	M	Wt. Less Bush
	OD	Pitch 8V															
6 8V 1250 TB	12.5	12.5	A-1	4040	4	1	4	2.125	100.0	8 8V 1250 TB	A-1	4545	4.5	1.5	4.5	3.375	125.0
6 8V 1320 TB	13.2	13.2	A-1	4040	4	1	4	2.125	124.0	8 8V 1320 TB	A-1	4545	4.5	1.5	4.5	3.375	135.0
6 8V 1400 TB	14	14	A-1	4040	4	1	4	2.125	142.0	8 8V 1400 TB	A-1	4545	4.5	1.5	4.5	3.375	156.0
6 8V 1500 TB	15	15	A-1	4545	4.5	.5	4.5	2.125	153.0	8 8V 1500 TB	A-1	4545	4.5	1.5	4.5	3.375	160.0
6 8V 1600 TB	16	16	A-2	4545	4.5	.5	4.5	2.125	170.0	8 8V 1600 TB	A-2	4545	4.5	1.5	4.5	3.375	166.0
6 8V 1700 TB	17	17	A-2	4545	4.5	.5	4.5	2.125	175.0	8 8V 1700 TB	A-2	5050	5	1	5	3.375	265.0
6 8V 1800 TB	18	18	A-2	4545	4.5	.5	4.5	2.125	180.0	8 8V 1800 TB	A-2	5050	5	1	5	3.375	204.0
6 8V 1900 TB	19	19	A-2	4545	4.5	.5	4.5	2.125	182.0	8 8V 1900 TB	A-2	5050	5	1	5	3.375	228.0
6 8V 2000 TB	20	20	A-2	5050	5	.5	5	1.625	226.0	8 8V 2000 TB	A-2	5050	5	1	5	3.375	234.0
6 8V 2120 TB	21.2	21.2	A-3	5050	5	.5	5	1.625	246.0	8 8V 2120 TB	A-3	5050	5	1	5	3.375	246.0
6 8V 2240 TB	22.4	22.4	A-3	5050	5	.5	5	1.625	267.0	8 8V 2240 TB	A-3	5050	5	1	5	3.375	300.0
6 8V 2480 TB	24.8	24.8	D-3	5050	5	.125	5	2.25	236.0	8 8V 2480 TB	A-3	5050	5	2.125	5	2.25	285.0
6 8V 3000 TB	30	30	A-3	5050	5	.5	5	1.625	398.0	8 8V 3000 TB	A-3	5050	5	1	5	3.375	384.0
6 8V 3550 TB	35.5	35.5	A-3	5050	5	.5	5	1.625	363.0	8 8V 3550 TB	A-3	5050	5	1	5	3.375	441.0
6 8V 4000 TB	40	40	A-3	5050	5	.5	5	1.625	468.0	8 8V 4000 TB	A-3	5050	5	1	5	3.375	556.0
6 8V 4450 TB	44.5	44.5	A-3	5050	5	.5	5	1.625	485.0	8 8V 4450 TB	A-3	5050	5	1	5	3.375	596.0
6 8V 5300 TB	53	53	A-3	5050	5	.5	5	1.625	658.0	8 8V 5300 TB	A-3	6050	6	1	5	3.375	1040.0

10 Grooves F = 11 5/8										12 Grooves F = 13 7/8							
Part Number	Diameter		Type	Bush	Bush Max Bore	E	L Length Thru Bore	M	Wt. Less Bush	Part Number	Type	Bush	Bush Max Bore	E	L Length Thru Bore	M	Wt. Less Bush
	OD	Pitch 8V															
-	-	-	-	-	-	-	-	-	-	12 8V 1250 TB	A-1	5050	5	3.1875	5	5.6875	153.0
10 8V 1320 TB	13.2	13.2	A-1	4545	4.5	1	4.5	6.125	150.0	12 8V 1320 TB	A-1	5050	5	3	5	5.875	180.0
10 8V 1400 TB	14	14	A-1	4545	4.5	1	4.5	6.125	180.0	12 8V 1400 TB	A-1	5050	5	3.1875	5	5.6875	186.0
10 8V 1500 TB	15	15	A-1	5050	5	1	5	5.625	211.0	12 8V 1500 TB	A-2	5050	5	1.875	5	7	221.0
10 8V 1600 TB	16	16	A-1	5050	5	1	5	5.625	220.0	12 8V 1600 TB	A-2	5050	5	1.875	5	7	247.0
10 8V 1700 TB	17	17	A-2	5050	5	2.25	5	4.375	228.0	12 8V 1700 TB	A-2	5050	5	3.5	5	5.375	267.0
10 8V 1800 TB	18	18	A-2	5050	5	2.25	5	4.375	244.0	12 8V 1800 TB	A-2	5050	5	3.5313	5	5.3438	274.0
10 8V 1900 TB	19	19	A-2	5050	5	2.25	5	4.375	260.0	12 8V 1900 TB	A-2	5050	5	2.25	5	6.625	306.0
10 8V 2000 TB	20	20	A-2	5050	5	2.25	5	4.375	270.0	12 8V 2000 TB	A-3	5050	5	2.25	5	6.625	249.0
10 8V 2120 TB	21.2	21.2	A-2	5050	5	2.25	5	4.375	282.0	12 8V 2120 TB	A-3	5050	5	2.25	5	6.625	294.0
10 8V 2240 TB	22.4	22.4	A-3	5050	5	2.25	5	4.375	312.0	12 8V 2240 TB	A-3	5050	5	2.25	5	6.625	337.0
10 8V 2480 TB	24.8	24.8	A-3	5050	5	2.375	5	4.25	328.0	12 8V 2480 TB	A-3	5050	5	5.375	5	3.5	380.0
10 8V 3000 TB	30	30	A-3	5050	5	2.25	5	4.375	448.0	12 8V 3000 TB	A-3	6050	6	4	5	4.875	482.0
10 8V 3550 TB	35.5	35.5	A-3	6050	6	2.25	5	4.375	517.0	12 8V 3550 TB	A-3	6050	6	4	5	4.875	597.0
10 8V 4000 TB	40	40	A-3	6050	6	2.25	5	4.375	550.0	12 8V 4000 TB	A-3	6050	6	4	5	4.875	911.5
10 8V 4450 TB	44.5	44.5	A-3	6050	6	2.25	5	4.375	701.0	12 8V 4450 TB	A-3	6050	6	4	5	4.875	814.0
10 8V 5300 TB	53	53	A-3	6050	6	2.25	5	4.375	870.0	12 8V 5300 TB	A-3	7060	6	5	5	2.875	1077.0

Dimensions in inches, weight in pounds. Weights do not include bushings. See page B-8 thru B-10 for additional bushing dimensions.

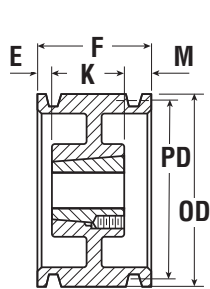

Type A

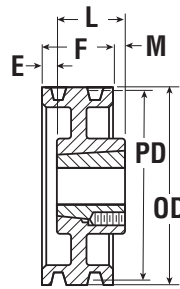

Type B

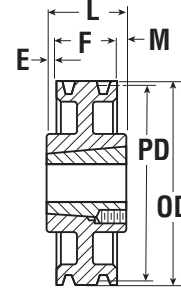

Type C

Taper Bushed Sheaves – A-B

1 Groove F = 1*											2 Grooves F = 1 3/4							
Part Number	Diameter		OD	Type	Bush	Bush Max Bore	E	L Length Thru Bore	M	Wt. Less Bush	Part Number	Type	Bush	Bush Max Bore	E	L Length Thru Bore	M	Wt. Less Bush
	A Belt	B Belt																
1 B 34 TB	3	3.4	3.75	A-1	1210	1.25	–	1	–	2.2	2 B 34 TB	A-1	1210	1.25	.75	1	–	2.2
1 B 36 TB	3.2	3.6	3.95	A-1	1210	1.25	–	1	–	2.6	2 B 36 TB	A-1	1210	1.25	.75	1	–	2.6
1 B 38 TB	3.4	3.8	4.15	A-1	1610	1.625	–	1	–	2.8	2 B 38 TB	A-1	1610	1.625	.75	1	–	2.8
1 B 40 TB	3.6	4	4.35	A-1	1610	1.625	–	1	–	3.0	2 B 40 TB	A-1	1610	1.625	.75	1	–	3.0
1 B 42 TB	3.8	4.2	4.55	A-1	1610	1.625	–	1	–	3.5	2 B 42 TB	A-1	1610	1.625	.75	1	–	4.0
1 B 44 TB	4	4.4	4.75	A-1	1610	1.625	–	1	–	3.8	2 B 44 TB	A-1	1610	1.625	.75	1	–	4.5
1 B 46 TB	4.2	4.6	4.95	A-1	1610	1.625	–	1	–	4.0	2 B 46 TB	A-1	1610	1.625	.75	1	–	5.0
1 B 48 TB	4.4	4.8	5.15	A-1	1610	1.625	–	1	–	4.5	2 B 48 TB	A-1	1610	1.625	.75	1	–	5.5
1 B 50 TB	4.6	5	5.35	A-1	1610	1.625	–	1	–	4.8	2 B 50 TB	A-1	1610	1.625	.75	1	–	6.0
1 B 52 TB	4.8	5.2	5.55	A-1	1610	1.625	–	1	–	5.0	2 B 52 TB	A-1	1610	1.625	.75	1	–	6.5
1 B 54 TB	5	5.4	5.75	A-1	1610	1.625	–	1	–	5.5	2 B 54 TB	A-1	1610	1.625	.75	1	–	7.0
1 B 56 TB	5.2	5.6	5.95	A-1	1610	1.625	–	1	–	6.0	2 B 56 TB	A-1	1610	1.625	.75	1	–	8.2
1 B 58 TB	5.4	5.8	6.15	A-1	1610	1.625	–	1	–	6.3	2 B 58 TB	A-1	1610	1.625	.75	1	–	8.6
1 B 60 TB	5.6	6	6.35	A-1	1610	1.625	–	1	–	6.7	2 B 60 TB	A-1	1610	1.625	.75	1	–	8.8
1 B 62 TB	5.8	6.2	6.55	A-1	1610	1.625	–	1	–	7.0	2 B 62 TB	A-1	1610	1.625	.75	1	–	9.0
1 B 64 TB	6	6.4	6.75	A-1	1610	1.625	–	1	–	8.0	2 B 64 TB	A-1	1610	1.625	.75	1	–	10.0
1 B 66 TB	6.2	6.6	6.95	A-1	1610	1.625	–	1	–	8.5	2 B 66 TB	A-1	1610	1.625	.75	1	–	10.5
1 B 68 TB	6.4	6.8	7.15	A-1	1610	1.625	–	1	–	9.0	2 B 68 TB	A-1	1610	1.625	.75	1	–	11.0
1 B 70 TB	6.6	7	7.35	B-1	2517	2.5	–	1.75	.75	8.5	–	–	–	–	–	–	–	–
1 B 74 TB	7	7.4	7.75	B-1	2517	2.5	–	1.75	.75	9.4	2 B 74 TB	A-1	2517	2.5	–	1.75	–	16.0
1 B 86 TB	8.2	8.6	8.95	B-2	2517	2.5	–	1.75	.75	12.0	2 B 86 TB	A-2	2517	2.5	–	1.75	–	18.0
1 B 94 TB	9	9.4	9.75	B-2	2517	2.5	–	1.75	.75	14.0	2 B 94 TB	A-2	2517	2.5	–	1.75	–	20.0
1 B 110 TB	10.6	11	11.35	B-2	2517	2.5	–	1.75	.75	15.6	2 B 110 TB	A-2	2517	2.5	–	1.75	–	25.0
1 B 124 TB	12	12.4	12.75	C-3	2517	2.5	.25	1.75	.5	16.2	2 B 124 TB	A-3	2517	2.5	–	1.75	–	27.0
1 B 136 TB	13.2	13.6	13.95	C-3	2517	2.5	.25	1.75	.5	17.2	2 B 136 TB	C-3	2517	2.5	–	1.75	–	24.0
1 B 154 TB	15	15.4	15.75	C-3	2517	2.5	.25	1.75	.5	18.0	2 B 154 TB	A-3	2517	2.5	–	1.75	–	31.0
1 B 160 TB	16	16.4	16.35	C-3	2517	2.5	.375	1.75	.375	24.1	2 B 160 TB	C-3	2517	2.5	–	1.75	–	26.0
1 B 184 TB	18	18.4	18.75	C-3	2517	2.5	.1875	1.75	.4375	31.2	2 B 184 TB	A-3	2517	2.5	–	1.75	–	33.0
–	19.6	20.0	20.35	–	–	–	–	–	–	–	2 B 200 TB	C-3	3020	3	–	2	.25	49.0
–	24.6	25.0	25.35	–	–	–	–	–	–	–	2 B 250 TB	C-3	3020	3	–	2	.25	65.0
–	29.6	30.0	30.35	–	–	–	–	–	–	–	2 B 300 TB	C-3	3020	3	–	2	.25	75.0
–	37.6	38.0	38.35	–	–	–	–	–	–	–	2 B 380 TB	C-3	3020	3	–	2	.25	112.0

Dimensions in inches, weight in pounds. Weights do not include bushings. See page B-8 thru B-10 for additional bushing dimensions.

* F = 1" 1 B 154 TB

F = 1.125" for 1 B 184 TB

A-B Combination Groove Conventional Taper Bushed Stock Sheaves



1=SOLID

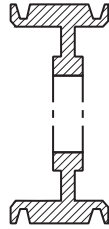

2=WEB

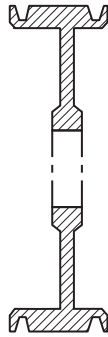

3=ARM/SPOKE

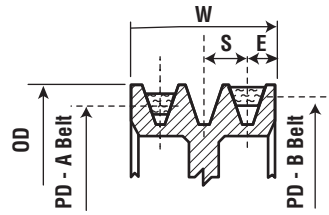

Combination Groove Dimensions

Belt Selection	E	S	OD
AB	.5	.75	PD B + .35

W = S (N-1) + 2E
 N = No. of Grooves

Drawing shows position of "A" and "B" belts in groove.

Taper Bushed Sheaves – A-B

3 Grooves F = 2 1/2											4 Grooves F = 3 1/4							
Part Number	Diameter		OD	Type	Bush	Bush Max Bore	E	L Length Thru Bore	M	Wt. Less Bush	Part Number	Type	Bush	Bush Max Bore	E	L Length Thru Bore	M	Wt. Less Bush
	A Belt	B Belt																
3 B 34 TB	3	3.4	3.75	A-1	1210	1.25	1.5	1	-	3.0	4 B 34 TB	A-1	1210	1.25	2.25	1	-	3.0
3 B 36 TB	3.2	3.6	3.95	A-1	1210	1.25	1.5	1	-	3.5	4 B 36 TB	A-1	1210	1.25	2.25	1	-	3.5
3 B 38 TB	3.4	3.8	4.15	A-1	1610	1.625	1.5	1	-	4.0	4 B 38 TB	A-1	1610	1.625	2.25	1	-	4.0
3 B 40 TB	3.6	4	4.35	A-1	1610	1.625	1.5	1	-	5.0	4 B 40 TB	A-1	1610	1.625	2.25	1	-	5.0
3 B 42 TB	3.8	4.2	4.55	A-1	1610	1.625	1.5	1	-	6.0	4 B 42 TB	A-1	1610	1.625	2.25	1	-	5.5
3 B 44 TB	4	4.4	4.75	A-1	1610	1.625	1.5	1	-	6.5	4 B 44 TB	A-1	1610	1.625	2.25	1	-	6.0
3 B 46 TB	4.2	4.6	4.95	A-1	1610	1.625	1.5	1	-	7.0	4 B 46 TB	A-1	1610	1.625	2.25	1	-	7.0
3 B 48 TB	4.4	4.8	5.15	A-1	1610	1.625	1.5	1	-	8.0	4 B 48 TB	A-1	1610	1.625	2.25	1	-	8.0
3 B 50 TB	4.6	5	5.35	A-1	1610	1.625	1.5	1	-	8.5	4 B 50 TB	A-1	2517	2.5	1.5	1.75	-	8.5
3 B 52 TB	4.8	5.2	5.55	A-1	1610	1.625	1.5	1	-	9.0	4 B 52 TB	A-1	2517	2.5	1.5	1.75	-	9.0
3 B 54 TB	5	5.4	5.75	A-1	2517	2.5	1.5	1.75	-	9.5	4 B 54 TB	A-1	2517	2.5	1.5	1.75	-	9.5
3 B 56 TB	5.2	5.6	5.95	A-1	2517	2.5	1.5	1.75	-	10.0	4 B 56 TB	A-1	2517	2.5	1.5	1.75	-	10.0
3 B 58 TB	5.4	5.8	6.15	A-1	2517	2.5	.75	1.75	-	10.5	4 B 58 TB	A-1	2517	2.5	1.5	1.75	-	12.0
3 B 60 TB	5.6	6	6.35	A-1	2517	2.5	.75	1.75	-	11.0	4 B 60 TB	A-1	2517	2.5	1.5	1.75	-	12.5
3 B 62 TB	5.8	6.2	6.55	A-1	2517	2.5	.75	1.75	-	11.5	4 B 62 TB	A-1	2517	2.5	1.5	1.75	-	13.0
3 B 64 TB	6	6.4	6.75	A-1	2517	2.5	.75	1.75	-	12.0	4 B 64 TB	A-1	2517	2.5	1.5	1.75	-	14.0
3 B 66 TB	6.2	6.6	6.95	A-1	2517	2.5	.75	1.75	-	12.3	4 B 66 TB	A-1	2517	2.5	1.5	1.75	-	15.0
3 B 68 TB	6.4	6.8	7.15	A-1	2517	2.5	.75	1.75	-	12.8	4 B 68 TB	A-1	2517	2.5	1.5	1.75	-	16.0
-	-	-	-	-	-	-	-	-	-	-	4 B 70 TB	A-1	2517	2.5	-	1.75	1.5	20.0
3 B 74 TB	7	7.4	7.75	A-1	2517	2.5	.75	1.75	-	16.0	4 B 74 TB	A-1	2517	2.5	1.5	1.75	-	16.0
3 B 80 TB	8	8.4	8.35	A-1	2517	2.5	-	1.75	.75	19.0	4 B 80 TB	A-1	2517	2.5	-	1.75	1.5	21.0
3 B 86 TB	8.2	8.6	8.95	A-2	2517	2.5	.75	1.75	-	19.0	4 B 86 TB	A-2	2517	2.5	1.5	1.75	-	21.0
3 B 94 TB	9	9.4	9.75	A-2	2517	2.5	.75	1.75	-	21.0	4 B 94 TB	A-2	2517	2.5	1.5	1.75	-	23.0
3 B 110 TB	10.6	11	11.35	A-2	2517	2.5	.75	1.75	-	24.0	4 B 110 TB	A-2	2517	2.5	1.5	1.75	-	28.0
3 B 124 TB	12	12.4	12.75	A-3	2517	2.5	-	1.75	.75	28.0	4 B 124 TB	A-3	2517	2.5	.375	1.75	1.125	32.8
3 B 136 TB	13.2	13.6	13.95	A-3	2517	2.5	-	1.75	.75	25.0	4 B 136 TB	A-3	2517	2.5	.375	1.75	1.125	34.0
3 B 154 TB	15	15.4	15.75	A-3	2517	2.5	-	1.75	.75	30.0	4 B 154 TB	A-3	2517	2.5	.375	1.75	1.125	42.0
3 B 160 TB	15.6	16	16.35	A-3	2517	2.5	-	1.75	.75	32.0	4 B 160 TB	A-3	2517	2.5	.375	1.75	1.125	45.1
3 B 184 TB	18	18.4	18.75	A-3	2517	2.5	-	1.75	.75	44.0	4 B 184 TB	A-3	2517	2.5	.5	1.75	1	53.0
3 B 200 TB	19.6	20	20.35	A-3	3020	3	-	2	.5	58.0	4 B 200 TB	A-3	3020	3	.5	2	.75	63.0
3 B 250 TB	24.6	25	25.35	A-3	3020	3	-	2	.5	74.0	4 B 250 TB	A-3	3030	3	-	3	1.25	80.0
3 B 300 TB	29.6	30	30.35	A-3	3020	3	-	2	.5	84.0	4 B 300 TB	A-3	3030	3	-	3	1.25	100.0
3 B 380 TB	37.6	38	38.35	B-3	3020	3	-	3	.5	135.0	4 B 380 TB	A-3	3030	3	-	3	1.25	142.0

Dimensions in inches, weight in pounds. Weights do not include bushings. See page B-8 thru B-10 for additional bushing dimensions.



Combination Groove Conventional Taper Bushed Stock Sheaves **A-B**



1=SOLID

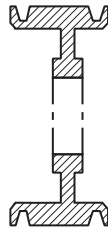

2=WEB

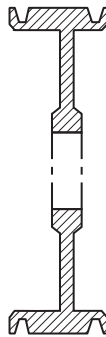

3=ARM/SPOKE

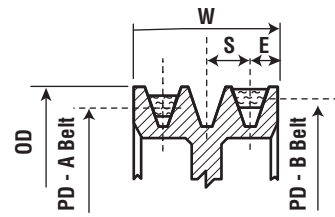

Combination Groove Dimensions

Belt Selection	E	S	OD
AB	.5	.75	PD B + .35

$W = S(N-1) + 2E$
 N = No. of Grooves

Drawing shows position of "A" and "B" belts in groove.

Taper Bushed Sheaves – A-B

5 Grooves F = 4											6 Grooves F = 4 3/4							
Part Number	Diameter		OD	Type	Bush	Bush Max Bore	E	L Length Thru Bore	M	Wt. Less Bush	Part Number	Type	Bush	Bush Max Bore	E	L Length Thru Bore	M	Wt. Less Bush
	A Belt	B Belt																
5 B 34 TB	3.0	3.4	3.75	A-1	1210	1.25	2.5	1.5	0	5.0								
5 B 36 TB	3.2	3.6	3.95	A-1	1210	1.25	2.5	1.5	0	5.5								
5 B 38 TB	3.4	3.8	4.15	A-1	1215	1.625	.875	1.5	1.625	6.0								
5 B 40 TB	3.6	4.0	4.35	A-1	1215	1.625	.875	1.5	1.625	6.5								
5 B 42 TB	3.8	4.2	4.55	A-1	1615	1.625	2.5	1.5	0	7.0	6 B 42 TB	A-1	1615	1.625	3.25	1.5	0	8.0
5 B 44 TB	4.0	4.4	4.75	A-1	1615	1.625	2.5	1.5	0	8.0	6 B 44 TB	A-1	1615	1.625	3.25	1.5	0	9.0
5 B 46 TB	4.2	4.6	4.95	A-1	1615	1.625	2.5	1.5	0	9.0	6 B 46 TB	A-1	1615	1.625	3.25	1.5	0	10.0
5 B 48 TB	4.8	5.2	5.15	A-1	1615	1.625	.875	1.5	1.625	9.4	6 B 48 TB	A-1	1615	1.625	1.25	1.5	2	11.0
5 B 50 TB	4.6	5.0	5.35	A-1	1615	1.625	.875	1.5	0	10.5	6 B 50 TB	A-1	1615	1.625	1.25	1.5	2	11.9
5 B 52 TB	4.8	5.2	5.55	A-1	1615	1.625	.875	1.5	0	11.3	6 B 52 TB	A-1	1615	1.625	1.25	1.5	2	12.8
5 B 54 TB	5.0	5.4	5.75	A-1	2517	2.5	2.25	1.75	0	11.5	6 B 54 TB	A-1	2517	1.625	1.25	1.5	2	13.7
5 B 56 TB	5.2	5.6	5.95	A-1	2517	2.5	2.25	1.75	0	12.0	6 B 56 TB	A-1	2517	1.625	1.25	1.5	2	14.6
5 B 58 TB	5.8	6.2	6.15	A-1	2517	2.5	.8125	1.75	1.4375	13.0	6 B 58 TB	A-1	2517	2.5	1.125	1.75	1.875	14.0
5 B 60 TB	5.6	6.0	6.35	A-1	2517	2.5	2.25	1.75	0	14.0	6 B 60 TB	A-1	2517	2.5	3	1.75	0	16.0
5 B 62 TB	6.2	6.6	6.55	A-1	2517	2.5	.8125	1.75	1.4375	14.0	6 B 62 TB	A-1	2517	2.5	1.125	1.75	1.875	16.0
5 B 64 TB	6.0	6.4	6.75	A-1	2517	2.5	2.25	1.75	0	16.0	6 B 64 TB	A-1	2517	2.5	3	1.75	0	19.5
5 B 66 TB	6.6	7.0	6.95	A-1	2517	2.5	.8125	1.75	1.4375	16.0	6 B 66 TB	A-1	2517	2.5	1.125	1.75	1.875	20.0
5 B 68 TB	6.4	6.8	7.15	A-1	2517	2.5	2.25	1.75	0	18.0	6 B 68 TB	A-1	2517	2.5	3	1.75	0	21.0
5 B 70 TB	7.0	7.4	7.35	A-1	2517	2.5	.75	1.75	1.5	18.0	6 B 70 TB	A-1	2517	2.5	1.5	1.75	1.5	21.0
5 B 74 TB	7.0	7.4	7.75	A-1	2517	2.5	2.25	1.75	0	22.0	6 B 74 TB	A-1	2517	2.5	3	1.75	0	25.0
5 B 80 TB	8.0	8.4	8.35	A-1	2517	2.5	.5	1.75	1.75	23.0	6 B 80 TB	A-1	2517	2.5	1.5	1.75	1.5	26.0
5 B 86 TB	8.2	8.6	8.95	A-2	2517	2.5	2.25	1.75	0	24.0	6 B 86 TB	A-2	2517	2.5	3	1.75	0	27.0
5 B 94 TB	9.0	9.4	9.75	A-2	2517	2.5	2.25	1.75	0	26.0	6 B 94 TB	A-2	2517	2.5	3	1.75	0	28.0
5 B 110 TB	10.6	11.0	11.35	A-2	2517	2.5	2.25	1.75	0	35.0	6 B 110 TB	A-2	2517	2.5	3	1.75	0	34.0
5 B 124 TB	12.0	12.4	12.75	A-3	2517	2.5	.75	1.75	1.5	40.0	6 B 124 TB	A-3	2517	2.5	1.125	1.75	1.875	43.0
5 B 136 TB	13.6	14.0	13.95	A-3	2517	2.5	1	1.75	1.25	38.0	6 B 136 TB	A-3	2517	2.5	1.5	1.75	1.5	42.0
5 B 154 TB	15.0	15.4	15.75	A-3	2517	2.5	.75	1.75	1.5	47.0	6 B 154 TB	A-3	2517	2.5	1.5	1.75	1.5	52.0
5 B 160 TB	16.0	16.4	16.35	A-3	2517	2.5	.75	1.75	1.5	67.0	6 B 160 TB	A-3	2517	2.5	1.5	1.75	1.5	53.0
5 B 184 TB	18.0	18.4	18.75	A-3	2517	2.5	.75	1.75	1.5	52.0	6 B 184 TB	A-3	2517	2.5	1.5	1.75	1.5	62.0
5 B 200 TB	19.6	20.0	20.35	A-3	3030	3	.25	3	.75	75.0	6 B 200 TB	A-3	3030	3	.5	3	1.25	85.0
5 B 250 TB	24.6	25.0	25.35	A-3	3030	3	.25	3	.75	81.0	6 B 250 TB	A-3	3030	3	.5	3	1.25	100.0
5 B 300 TB	29.6	30.0	30.35	A-3	3030	3	.25	3	.75	109.0	6 B 300 TB	A-3	3030	3	.5	3	1.25	137.0
5 B 380 TB	37.6	38.0	38.35	A-3	3030	3	.25	3	.75	158.0	6 B 380 TB	A-3	3030	3	.5	3	1.25	168.0

A-B Combination Groove Conventional Taper Bushed Stock Sheaves



1=SOLID

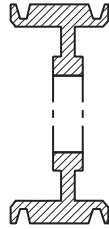

2=WEB

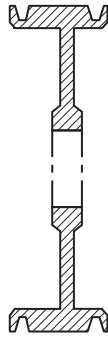

3=ARM/SPOKE

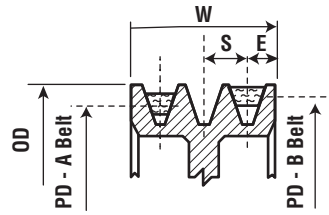

Combination Groove Dimensions

Belt Selection	E	S	OD
AB	.5	.75	PD B + .35

$W = S(N-1) + 2E$
 N = No. of Grooves

Drawing shows position of "A" and "B" belts in groove.

Taper Bushed Sheaves – A-B

8 Grooves F = 6 1/4											10 Grooves F = 7 3/4							
Part Number	Diameter		OD	Type	Bush	Bush Max Bore	E	L Length Thru Bore	M	Wt. Less Bush	Part Number	Type	Bush	Bush Max Bore	E	L Length Thru Bore	M	Wt. Less Bush
	A Belt	B Belt																
8 B 54 TB	5	5.4	5.75	A-1	2517	2.5	1.875	1.75	2.625	16.0	10 B 54 TB	A-1	2517	2.5	3	1.75	3	18.0
8 B 56 TB	5.2	5.6	5.95	A-1	2517	2.5	1.875	1.75	2.625	17.0	10 B 56 TB	A-1	2517	2.5	3	1.75	3	20.0
8 B 60 TB	5.6	6	6.35	A-1	2517	2.5	1.875	1.75	2.625	19.0	10 B 60 TB	A-1	2517	2.5	3	1.75	3	22.0
8 B 64 TB	6	6.4	6.75	A-1	2517	2.5	1.875	1.75	2.625	21.0	10 B 64 TB	A-1	2517	2.5	3	1.75	3	25.5
8 B 68 TB	6.4	6.8	7.15	A-1	2517	2.5	1.875	1.75	2.625	25.0	10 B 68 TB	A-1	2517	2.5	3	1.75	3	28.0
8 B 74 TB	7	7.4	7.75	A-1	2517	2.5	1.875	1.75	2.625	29.0	10 B 74 TB	A-1	2517	2.5	3	1.75	3	35.0
8 B 86 TB	8.2	8.6	8.95	A-1	3030	3	1	3	2.25	37.0	10 B 86 TB	A-1	3030	3	2	3	2.75	43.0
8 B 94 TB	9	9.4	9.95	A-2	3030	3	1	3	2.25	41.0	10 B 94 TB	A-2	3030	3	2	3	2.75	46.0
8 B 110 TB	10.6	11	11.35	A-2	3030	3	1	3	2.25	51.0	10 B 110 TB	A-2	3030	3	2	3	2.75	52.0
8 B 124 TB	12	12.4	12.75	A-3	3030	3	1	3	2.25	56.0	-	-	-	-	-	-	-	-
8 B 154 TB	15	15.4	15.75	A-3	3030	3	1	3	2.25	69.0	-	-	-	-	-	-	-	-
8 B 184 TB	18	18.4	18.75	A-3	3030	3	1	3	2.25	99.0	-	-	-	-	-	-	-	-
8 B 200 TB	19.6	20	20.35	A-3	3030	3	1	3	2.25	115.0	-	-	-	-	-	-	-	-
8 B 250 TB	24.6	25	25.35	A-3	3535	3.5	.75	3.5	2	145.0	-	-	-	-	-	-	-	-
8 B 300 TB	29.6	30	30.35	A-3	3535	3.5	.75	3.5	2	170.0	-	-	-	-	-	-	-	-
8 B 380 TB	37.6	38	38.35	A-3	4040	4	1.125	4	1.125	260.0	-	-	-	-	-	-	-	-

Dimensions in inches, weight in pounds. Weights do not include bushings. See page B-8 thru B-10 for additional bushing dimensions.

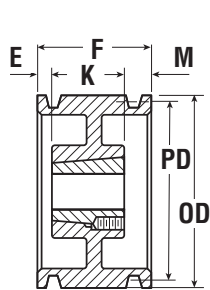

Type A

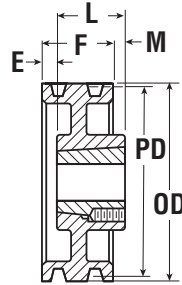

Type B

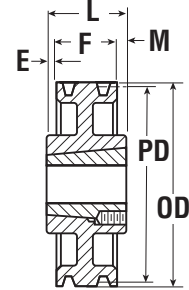

Type C

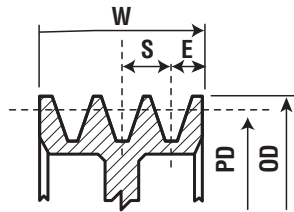

Combination Groove Dimensions

Belt Selection	E	S	OD
C	.6875	1	PD B + .40

$W = S(N-1) + 2E$
 N = No. of Grooves

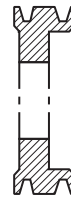

1=SOLID

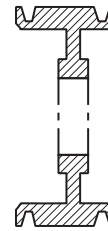

2=WEB

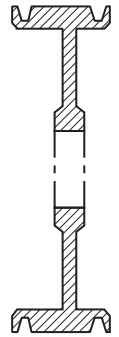

3=ARM/SPOKE

Taper Bushed Sheaves – C

2 Grooves F = 2 3/8										3 Grooves F = 3 3/8							
Part Number	PD	OD	Type	Bush	Bush Max Bore	E	L Length Thru Bore	M	Wt. Less Bush	Part Number	Type	Bush	Bush Max Bore	E	L Length Thru Bore	M	Wt. Less Bush
	C Belt																
2 C 70 TB	7	7.4	A-1	2517	2.5	.625	1.75	–	15.0	3 C 70 TB	A-1	2517	2.5	.25	1.75	1.375	18.0
2 C 75 TB	7.5	7.9	A-1	2517	2.5	.625	1.75	–	17.0	3 C 75 TB	A-1	2517	2.5	.25	1.75	1.375	20.0
2 C 80 TB	8	8.4	A-1	2517	2.5	.625	1.75	–	20.0	3 C 80 TB	A-1	2517	2.5	.25	1.75	1.375	22.0
2 C 85 TB	8.5	8.9	A-2	2517	2.5	.625	1.75	–	22.0	3 C 85 TB	A-2	2517	2.5	.25	1.75	1.375	23.0
2 C 90 TB	9	9.4	A-2	2517	2.5	.625	1.75	–	23.0	3 C 90 TB	A-2	2517	2.5	.25	1.75	1.375	24.0
2 C 95 TB	9.5	9.9	A-2	2517	2.5	.625	1.75	–	24.0	3 C 95 TB	A-2	2517	2.5	.25	1.75	1.375	27.0
2 C 100 TB	10	10.4	A-2	2517	2.5	.625	1.75	–	25.0	3 C 100 TB	A-2	2517	2.5	.25	1.75	1.375	29.0
2 C 105 TB	10.5	10.9	A-2	2517	2.5	.625	1.75	–	26.0	3 C 105 TB	A-2	2517	2.5	.25	1.75	1.375	32.0
2 C 110 TB	11	11.4	A-2	2517	2.5	.625	1.75	–	27.0	3 C 110 TB	A-2	2517	2.5	.25	1.75	1.375	35.0
2 C 120 TB	12	12.4	A-2	2517	2.5	.625	1.75	–	33.0	3 C 120 TB	A-2	3020	3	–	2	1.375	44.0
2 C 130 TB	13	13.4	A-3	2517	2.5	.625	1.75	–	35.0	3 C 130 TB	A-3	3020	3	–	2	1.375	49.0
2 C 140 TB	14	14.4	A-3	2517	2.5	.625	1.75	–	36.0	3 C 140 TB	A-3	3020	3	–	2	1.375	50.0
2 C 160 TB	16	16.4	A-3	2517	2.5	.625	1.75	–	42.0	3 C 160 TB	A-3	3020	3	–	2	1.375	64.0
2 C 180 TB	18	18.4	A-3	3020	3	–	2	.375	42.0	3 C 180 TB	A-3	3030	3	–	3	.375	64.0
2 C 200 TB	20	20.4	A-3	3020	3	–	2	.375	45.0	3 C 200 TB	A-3	3030	3	–	3	.375	78.0
2 C 240 TB	24	24.4	A-3	3020	3	–	2	.375	72.0	3 C 240 TB	A-3	3030	3	–	3	.375	96.0
2 C 300 TB	30	30.4	C-3	3535	3.5	.5	3.5	.625	85.0	3 C 300 TB	B-3	3535	3.5	–	3.5	.125	125.0
–	36	36.4	–	–	–	–	–	–	–	3 C 360 TB	B-3	3535	3.5	–	3.5	.125	175.0

Dimensions in inches, weight in pounds. Weights do not include bushings. See page B-8 thru B-10 for additional bushing dimensions.

C Conventional Stock Taper Bushed Sheaves

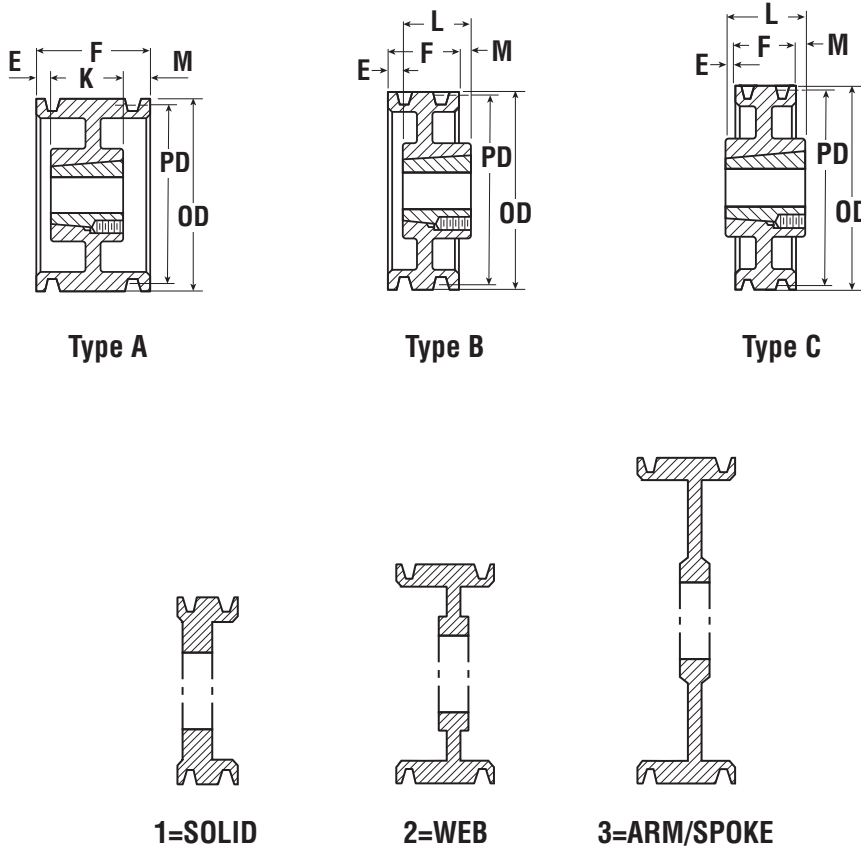

Taper Bushed Sheaves – C

4 Grooves F = 4 3/8										5 Grooves F = 5 3/8							
Part Number	PD	OD	Type	Bush	Bush Max Bore	E	L Length Thru Bore	M	Wt. Less Bush	Part Number	Type	Bush	Bush Max Bore	E	L Length Thru Bore	M	Wt. Less Bush
	C Belt																
4 C 70 TB	7	7.4	A-1	2517	2.5	.5	1.75	2.125	20.0	5 C 70 TB	A-1	2517	2.5	1.5	1.75	2.125	23.0
4 C 75 TB	7.5	7.9	A-1	2517	2.5	.5	1.75	2.125	23.0	5 C 75 TB	A-1	2517	2.5	1.5	1.75	2.125	26.0
4 C 80 TB	8	8.4	A-1	2517	2.5	.5	1.75	2.125	25.0	5 C 80 TB	A-1	2517	2.5	1.5	1.75	2.125	30.0
4 C 85 TB	8.5	8.9	A-2	2517	2.5	.5	1.75	2.125	26.0	5 C 85 TB	A-1	2517	2.5	1.5	1.75	2.125	34.0
4 C 90 TB	9	9.4	A-2	2517	2.5	.5	1.75	2.125	27.0	5 C 90 TB	A-2	2517	2.5	1.5	1.75	2.125	35.0
4 C 95 TB	9.5	9.9	A-2	2517	2.5	.5	1.75	2.125	36.0	5 C 95 TB	A-2	2517	2.5	1.5	1.75	2.125	36.0
4 C 100 TB	10	10.4	A-2	2517	2.5	.5	1.75	2.125	39.0	5 C 100 TB	A-2	2517	2.5	1.5	1.75	2.125	39.0
4 C 105 TB	10.5	10.9	A-2	2517	2.5	.5	1.75	2.125	42.0	5 C 105 TB	A-2	2517	2.5	1.5	1.75	2.125	42.0
4 C 110 TB	11	11.4	A-2	2517	2.5	.5	1.75	2.125	45.0	5 C 110 TB	A-2	2517	2.5	1.5	1.75	2.125	43.0
4 C 120 TB	12	12.4	A-2	3030	3	–	3	1.375	47.0	5 C 120 TB	A-2	3030	3	.5	3	1.875	58.0
4 C 130 TB	13	13.4	A-3	3030	3	–	3	1.375	51.0	5 C 130 TB	A-3	3030	3	.5	3	1.875	63.0
4 C 140 TB	14	14.4	A-3	3030	3	–	3	1.375	54.0	5 C 140 TB	A-3	3030	3	.5	3	1.875	65.0
4 C 160 TB	16	16.4	A-3	3030	3	–	3	1.375	71.0	5 C 160 TB	A-3	3030	3	.5	3	1.875	70.0
4 C 180 TB	18	18.4	A-3	3030	3	–	3	1.375	81.0	5 C 180 TB	A-3	3030	3	.5	3	1.875	83.0
4 C 200 TB	20	20.4	A-3	3030	3	–	3	1.375	84.0	5 C 200 TB	A-3	3535	3.5	–	3.5	1.875	110.0
4 C 240 TB	24	24.4	A-3	3030	3	–	3	1.375	116.0	5 C 240 TB	A-3	3535	3.5	–	3.5	1.875	138.0
4 C 300 TB	30	30.4	A-3	3535	3.5	–	3.5	.875	164.0	5 C 300 TB	A-3	3535	3.5	–	3.5	1.875	176.0
4 C 360 TB	36	36.4	A-3	3535	3.5	–	3.5	.875	192.0	5 C 360 TB	A-3	4040	4	.25	4	1.125	244.0
4 C 440 TB	44	44.4	A-3	4040	4	–	4	.375	282.0	5 C 440 TB	A-3	4040	4	.25	4	1.125	288.0

Dimensions in inches, weight in pounds. Weights do not include bushings. See page B-8 thru B-10 for additional bushing dimensions.

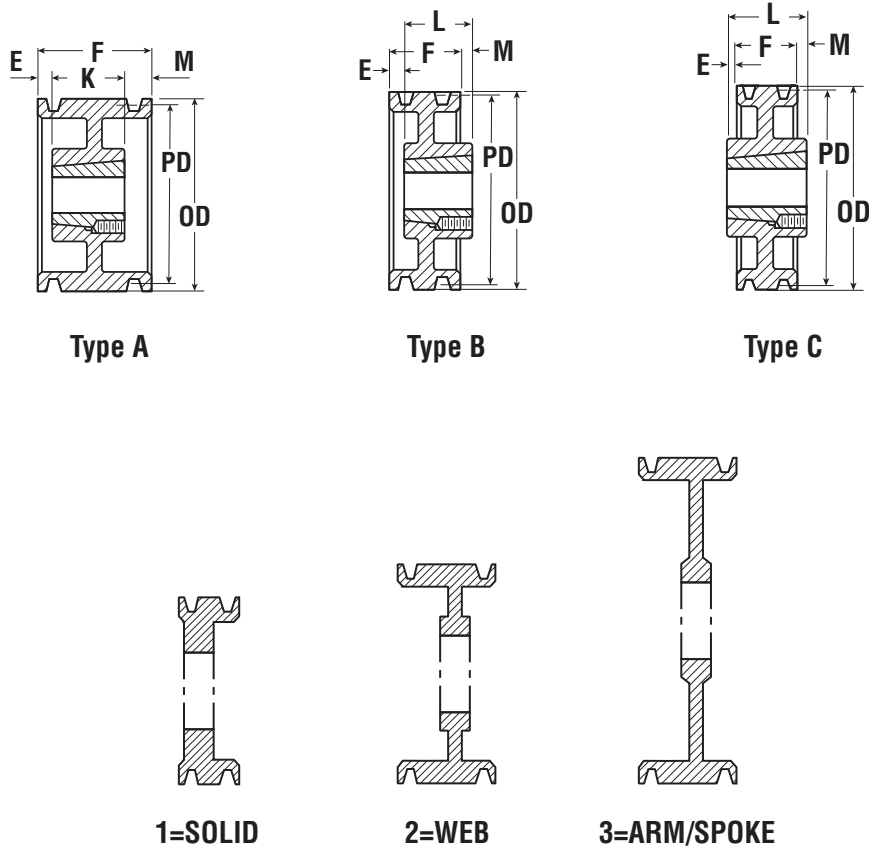

Taper Bushed Sheaves – C

6 Grooves F = 6 3/8										8 Grooves F = 8 3/8							
Part Number	PD	OD	Type	Bush	Bush Max Bore	E	L Length Thru Bore	M	Wt. Less Bush	Part Number	Type	Bush	Bush Max Bore	E	L Length Thru Bore	M	Wt. Less Bush
	C Belt																
6 C 70 TB	7	7.4	A-1	3030	3	1	3	2.375	30.0	—	—	—	—	—	—	—	—
6 C 75 TB	7.5	7.9	A-1	3030	3	1	3	2.375	31.0	—	—	—	—	—	—	—	—
6 C 80 TB	8	8.4	A-1	3030	3	1	3	2.375	35.0	8 C 80 TB	A-1	3030	3	2	3	3.375	45.0
6 C 85 TB	8.5	8.9	A-1	3030	3	1	3	2.375	40.0	8 C 85 TB	A-1	3030	3	2	3	3.375	47.0
6 C 90 TB	9	9.4	A-1	3030	3	1	3	2.375	47.0	8 C 90 TB	A-1	3535	3.5	1.5	3.5	3.375	64.0
6 C 95 TB	9.5	9.9	A-1	3030	3	1	3	2.375	53.0	8 C 95 TB	A-1	3535	3.5	1.5	3.5	3.375	67.0
6 C 100 TB	10	10.4	A-1	3030	3	1	3	2.375	57.0	8 C 100 TB	A-1	3535	3.5	1.5	3.5	3.375	70.0
6 C 105 TB	10.5	10.9	A-2	3030	3	1	3	2.375	58.0	8 C 105 TB	A-1	3535	3.5	1.5	3.5	3.375	84.0
6 C 110 TB	11	11.4	A-2	3030	3	1	3	2.375	66.0	8 C 110 TB	A-1	3535	3.5	1.5	3.5	3.375	87.0
6 C 120 TB	12	12.4	A-2	3030	3	1	3	2.375	70.0	8 C 120 TB	A-2	3535	3.5	1.5	3.5	3.375	90.0
6 C 130 TB	13	13.4	A-3	3030	3	1	3	2.375	75.0	8 C 130 TB	A-2	3535	3.5	1.5	3.5	3.375	97.0
6 C 140 TB	14	14.4	A-3	3535	3.5	.5	3.5	2.375	80.0	8 C 140 TB	A-2	3535	3.5	1.5	3.5	3.375	105.0
6 C 160 TB	16	16.4	A-3	3535	3.5	.5	3.5	2.375	87.0	8 C 160 TB	A-3	3535	3.5	1.5	3.5	3.375	115.0
6 C 180 TB	18	18.4	A-3	3535	3.5	.5	3.5	2.375	102.0	8 C 180 TB	A-3	4040	4	1.5	4	2.875	137.0
6 C 200 TB	20	20.4	A-3	3535	3.5	.5	3.5	2.375	126.0	8 C 200 TB	A-3	4040	4	1.5	4	2.875	180.0
6 C 240 TB	24	24.4	A-3	3535	3.5	.5	3.5	2.375	150.0	8 C 240 TB	A-3	4040	4	1.5	4	2.875	205.0
6 C 300 TB	30	30.4	A-3	4040	4	1	4	1.375	226.0	8 C 300 TB	A-3	4040	4	1.5	4	2.875	263.0
6 C 360 TB	36	36.4	A-3	4040	4	1	4	1.375	270.0	8 C 360 TB	A-3	4545	4.5	1.25	4.5	2.625	343.0
6 C 440 TB	44	44.4	A-3	4040	4	1	4	1.375	320.0	8 C 440 TB	A-3	4545	4.5	1.25	4.5	2.625	432.0

Dimensions in inches, weight in pounds. Weights do not include bushings. See page B-8 thru B-10 for additional bushing dimensions.

C Conventional Stock Taper Bushed Sheaves

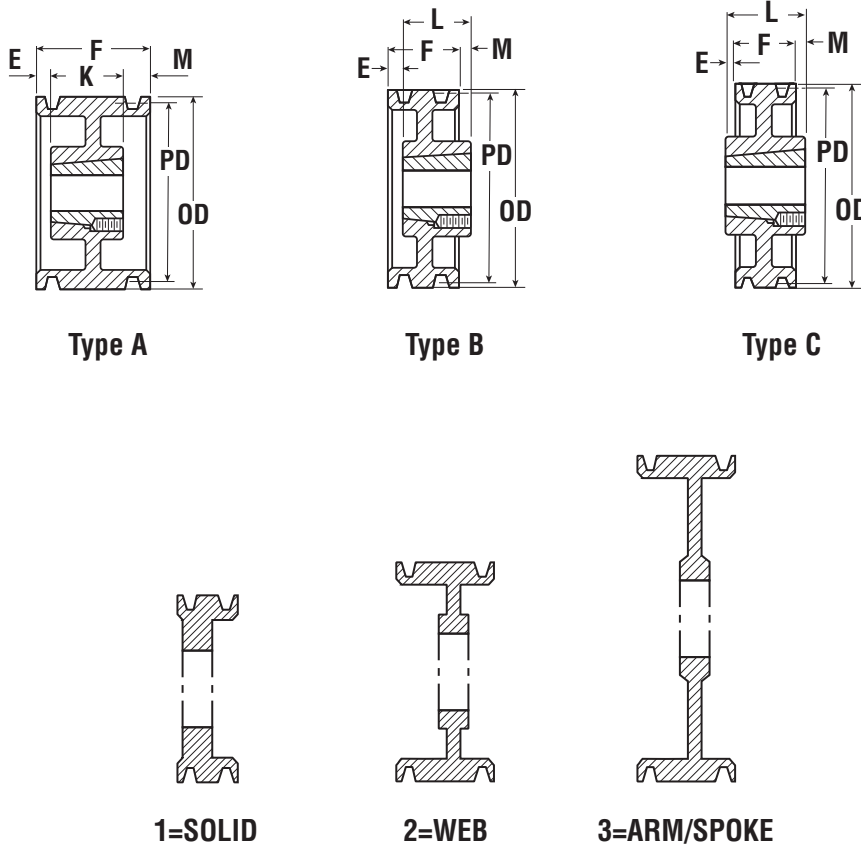

Taper Bushed Sheaves – C

10 Grooves F = 10 ³ / ₈										12 Grooves F = 12 ³ / ₈							
Part Number	PD	OD	Type	Bush	Bush Max Bore	E	L Length Thru Bore	M	Wt. Less Bush	Part Number	Type	Bush	Bush Max Bore	E	L Length Thru Bore	M	Wt. Less Bush
	C Belt																
10 C 90 TB	9	9.4	A-1	4545	4.5	1.5	4.5	4.375	57.0	12 C 90 TB	A-1	4040	4	3.5	4	4.875	65.0
10 C 95 TB	9.5	9.9	A-1	4545	4.5	1.5	4.5	4.375	66.0	12 C 95 TB	A-1	4040	4	3.5	4	4.875	75.0
10 C 100 TB	10	10.4	A-1	4545	4.5	1.5	4.5	4.375	77.0	12 C 100 TB	A-1	4040	4	3.5	4	4.875	85.0
10 C 105 TB	10.5	10.9	A-1	4545	4.5	1.5	4.5	4.375	87.0	12 C 105 TB	A-1	4040	4	3.5	4	4.875	95.0
10 C 110 TB	11	11.4	A-1	4545	4.5	1.5	4.5	4.375	98.0	12 C 110 TB	A-1	4040	4	3.5	4	4.875	104.0
10 C 120 TB	12	12.4	A-1	4545	4.5	1.5	4.5	4.375	121.0	12 C 120 TB	A-1	4040	4	3.5	4	4.875	126.0
10 C 130 TB	13	13.4	A-1	4545	4.5	2	4.5	3.875	146.0	12 C 130 TB	A-1	4545	4.5	3	4.5	4.875	156.0
10 C 140 TB	14	14.4	A-2	4545	4.5	2	4.5	3.875	170.1	12 C 140 TB	A-1	4545	4.5	3	4.5	4.875	184.0
10 C 160 TB	16	16.4	A-2	4545	4.5	2	4.5	3.875	173.4	–	–	–	–	–	–	–	
10 C 180 TB	18	18.4	A-2	4545	4.5	2	4.5	3.875	180.1	–	–	–	–	–	–	–	
10 C 200 TB	20	20.4	A-3	4545	4.5	2	4.5	3.875	201.0	–	–	–	–	–	–	–	
10 C 240 TB	24	24.4	A-3	4545	4.5	2	4.5	3.875	243.0	–	–	–	–	–	–	–	
10 C 300 TB	30	30.4	A-3	4545	4.5	2	4.5	3.875	320.0	–	–	–	–	–	–	–	
10 C 360 TB	36	36.4	A-3	4545	4.5	2	4.5	3.875	464.0	–	–	–	–	–	–	–	
10 C 440 TB	44	44.4	A-3	4545	4.5	2	4.5	3.875	508.0	–	–	–	–	–	–	–	

Dimensions in inches, weight in pounds. Weights do not include bushings. See page B-8 thru B-10 for additional bushing dimensions.