

High HP HTS Synchronous Sprockets



“W” High HP HTS® Sprockets (RPP® Tooth Profile) – Run with Hawk Pd®, Panther®, QT Power Chain® belts.

“W” High HP HTS® Sprockets are designed to run with latest design, higher horsepower belts.

Martin's High HP HTS® Sprockets are designed to run with today's highest horsepower RPP® profile belts.

High HP HTS® Synchronous Sprockets allow you more flexibility in your selection criteria. The expanded line allows you to fit the application with the most cost effective sprockets.

W 24 8M 22 - JA

High HP HTS®		Bushing or MPB
Number of Teeth		
Belt Pitch		Belt Width (mm)
8mm	12, 22, 35, 60
14mm	20, 42, 65, 90, 120

- Available in 8mm and 14mm pitches
- Belt widths: 12mm, 22mm, 35mm, 60mm (8mm pitch)
20mm, 42mm, 65mm, 90mm, 120mm (14mm pitch)
- Available in QD, TB or MPB styles from stock.
- **Typical Part Number: W248M22-JA**

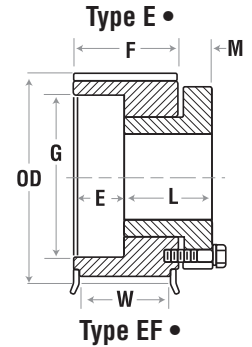
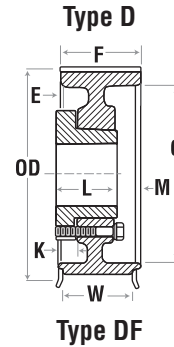
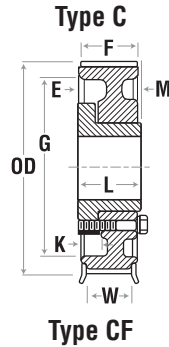
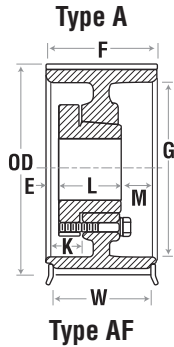

No. of Teeth	Catalog Number	Bore	Pitch	Diameter		Type +	Max Bore	Dimensions							Weight Approx. (lbs.)	
				O.D.	Flange			E	L	M	K	H	F	G		W
8mm Pitch, 12 mm (.47 in.) Wide Belts (8M-12)																
22	W228M12-MPB	MPB	2.206	2.154	2.562	MPB	1.188	0.623	1.452	—	—	1.620	0.827	—	0.577	1.0
24	W248M12-JA	JA	2.406	2.354	2.75	EF-1•	1.25	0.265	1.063	0.5	—	—	0.827	1.34	0.577	0.5
26	W268M12-JA	JA	2.607	2.554	2.937	EF-1•	1.25	0.265	1.063	0.5	—	—	0.827	1.34	0.577	0.6
28	W288M12-H	H	2.807	2.755	3.156	EF-1•	1.5	-0.048	1.25	0.375	—	—	0.827	1.57	0.577	0.7
30	W308M12-H	H	3.008	2.955	3.344	EF-1•	1.5	-0.048	1.25	0.375	—	—	0.827	1.57	0.577	0.9
32	W328M12-H	H	3.208	3.155	3.562	EF-1•	1.5	-0.048	1.25	0.375	—	—	0.827	1.57	0.577	1.1
34	W348M12-SH	SH	3.409	3.355	3.75	DF-1	1.688	0.5	1.313	0.014	—	—	0.827	2.75	0.577	1.1
36	W368M12-SH	SH	3.609	3.556	3.937	DF-1	1.688	0.5	1.313	0.014	—	—	0.827	2.82	0.577	1.3
38	W388M12-SH	SH	3.810	3.756	4.156	DF-1	1.688	0.5	1.313	0.014	—	—	0.827	3	0.577	1.6
40	W408M12-SH	SH	4.010	3.956	4.344	DF-1	1.688	0.5	1.313	0.014	—	—	0.827	3	0.577	1.9
44	W448M12-SDS	SDS	4.411	4.357	4.75	CF-1	2	0.548	1.375	—	0.077	—	0.827	3.5	0.577	2.1
48	W488M12-SDS	SDS	4.812	4.757	5.157	CF-1	2	0.548	1.375	—	0.077	—	0.827	3.800	0.577	2.7
56	W568M12-SDS	SDS	5.614	5.558	5.937	CF-1	2	0.548	1.375	—	0.077	—	0.827	4.600	0.577	4.0
64	W648M12-SDS	SDS	6.416	6.359	6.75	CF-1	2	0.548	1.375	—	0.077	—	0.827	5.400	0.577	5.5
72	W728M12-SDS	SDS	7.218	7.16	7.562	CF-1	2	0.548	1.375	—	0.077	—	0.827	6.200	0.577	7.3
80	W808M12-SDS	SDS	8.020	7.961	8.375	CF-2	2	0.548	1.375	—	0.077	—	0.827	6.900	0.577	9.2
90	W908M12-SDS	SDS	9.023	8.963	—	C-2	2	0.548	1.375	—	0.077	—	0.827	7.625	—	9.5
112	W1128M12-SK	SK	11.229	11.166	—	C-3	2.625	0.688	1.938	0.423	—	—	0.827	9.875	—	13.3
144	W1448M12-SK	SK	14.447	14.37	—	C-3	2.625	0.688	1.938	0.423	—	—	0.827	12.875	—	19.1
192	W1928M12-SF	SF	19.249	19.176	—	C-3	2.938	0.813	2.063	0.423	—	—	0.827	17.625	—	23.0
8mm Pitch, 22 mm (.86 in.) Wide Belts (8M-22)																
22	W228M22-MPB	MPB	2.206	2.154	2.562	MPBF-1	1.188	0.619	1.84	—	—	1.625	1.22	—	0.97	1.3
24	W248M22-JA	JA	2.406	2.354	2.750	EF-1•	1.25	0.658	1.063	0.5	—	—	1.22	1.34	0.97	0.7
26	W268M22-JA	JA	2.607	2.554	2.937	EF-1•	1.25	0.658	1.063	0.5	—	—	1.22	1.34	0.97	1.0
28	W288M22-H	H	2.807	2.755	3.156	EF-1•	1.5	0.345	1.25	0.375	—	—	1.22	1.57	0.97	1.1
30	W308M22-H	H	3.008	2.955	3.344	EF-1•	1.5	0.345	1.25	0.375	—	—	1.22	1.57	0.97	1.3
32	W328M22-H	H	3.208	3.155	3.562	CF-1•	1.5	0.030	1.25	—	0.345	—	1.22	1.57	0.97	1.7
34	W348M22-SH	SH	3.409	3.355	3.75	DF-1	1.688	0.092	1.313	—	0.408	—	1.22	2.75	0.97	1.3
36	W368M22-SH	SH	3.609	3.556	3.937	DF-1	1.688	0.092	1.313	—	0.408	—	1.22	2.82	0.97	1.6
38	W388M22-SH	SH	3.810	3.756	4.156	DF-1	1.688	0.092	1.313	—	0.408	—	1.22	3	0.97	1.9
40	W408M22-SH	SH	4.010	3.956	4.344	DF-1	1.688	0.092	1.313	—	0.408	—	1.22	3	0.97	2.3
44	W448M22-SDS	SDS	4.411	4.357	4.75	DF-1	2	0.155	1.375	—	0.47	—	1.22	3.5	0.97	2.5
48	W488M22-SDS	SDS	4.812	4.757	5.157	DF-1	2	0.155	1.375	—	0.47	—	1.22	3.8	0.97	3.2
56	W568M22-SDS	SDS	5.614	5.558	5.937	DF-1	2	0.155	1.375	—	0.47	—	1.22	4.6	0.97	4.6
64	W648M22-SK	SK	6.416	6.359	6.75	DF-1	2.625	0.438	1.938	-0.28	0.25	—	1.22	5.4	0.97	7.7
72	W728M22-SK	SK	7.218	7.16	7.562	DF-1	2.625	0.438	1.938	-0.28	0.25	—	1.22	6.2	0.97	9.1
80	W808M22-SK	SK	8.020	7.961	8.375	DF-2	2.625	0.438	1.938	-0.28	0.25	—	1.22	6.9	0.97	9.1
90	W908M22-SK	SK	9.023	8.963	—	D-2	2.625	0.438	1.938	-0.28	0.25	—	1.22	7.63	—	12.0
112	W1128M22-SK	SK	11.229	11.166	—	D-3	2.625	0.438	1.938	-0.28	0.25	—	1.22	9.88	—	15.3
144	W1448M22-SF	SF	14.447	14.37	—	D-3	2.938	0.563	2.063	-0.28	0.25	—	1.22	12.88	—	19.1
192	W1928M22-E	E	19.249	19.176	—	C-3	3.5	1.202	2.625	0.202	-0.202	—	1.22	17.63	—	38.4

* Weight Shown is for Sprocket Less Bushing.
• Reverse Mount Only

+ The numbers (1=Solid, 2=Web, 3=Arms) within the "Type" indicates construction, and the letter F indicates the sprocket has flanges.

High HP HTS® Sprockets

8mm



Type MPB

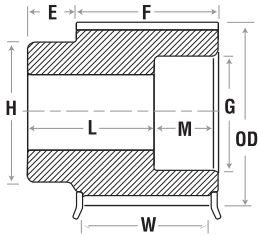

Type K

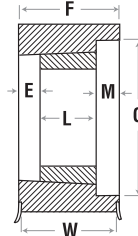

Type W

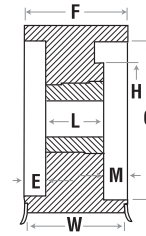

Type MPBF

Type KF

Type WF

No. of Teeth	Catalog Number	Bore	Pitch	Diameter		Type +	Max Bore	Dimensions								Weight Approx. (lbs.)
				O.D.	Flange			E	L	M	K	H	F	G	W	
8mm Pitch, 35 mm (1.38in.) Wide Belts (8M - 35)																
22	W228M35-MPB	MPB	2.206	2.154	2.56	MBPF-1	1.188	0.618	2.35	—	—	1.625	1.73	—	1.428	1.6
24	W248M35-MPB	MPB	2.406	2.354	2.75	MBPF-1	1.250	0.618	2.35	—	—	1.8125	1.73	—	1.428	2.0
26	W268M35-MPB	MPB	2.607	2.554	2.94	MBPF-1	1.375	0.618	2.35	—	—	2	1.73	—	1.428	2.4
28	W288M35-H	H	2.807	2.755	3.16	EF-1 •	1.5	0.855	1.25	0.375	—	—	1.73	1.57	1.428	1.5
30	W308M35-H	H	3.008	2.955	3.34	EF-1 •	1.5	0.855	1.25	0.375	—	—	1.73	1.57	1.428	1.9
32	W328M35-H	H	3.208	3.155	3.56	AF-1 •	1.5	0.245	1.25	0.235	0.62	—	1.73	1.57	1.428	2.4
34	W348M35-SH	SH	3.409	3.355	3.75	AF-1	1.688	0.12	1.3125	0.298	0.62	—	1.73	2.75	1.428	2.4
36	W368M35-SH	SH	3.609	3.556	3.94	AF-1	1.688	0.12	1.3125	0.298	0.62	—	1.73	2.82	1.428	2.8
38	W388M35-SH	SH	3.81	3.756	4.16	AF-1	1.688	0.12	1.3125	0.298	0.62	—	1.73	3	1.428	3.0
40	W408M35-SH	SH	4.01	3.956	4.34	AF-1	1.688	0.12	1.3125	0.298	0.62	—	1.73	3	1.428	2.8
44	W448M35-SD	SD	4.411	4.357	4.75	DF-1	2	0.313	1.8125	0.232	0.25	—	1.73	3.5	1.428	3.1
48	W488M35-SD	SD	4.812	4.757	5.16	DF-1	2	0.313	1.8125	0.232	0.25	—	1.73	3.8	1.428	3.5
56	W568M35-SK	SK	5.614	5.558	5.94	DF-1	2.625	0.438	1.9375	0.23	0.25	—	1.73	4.6	1.428	5.3
64	W648M35-SK	SK	6.416	6.359	6.75	DF-1	2.625	0.438	1.9375	0.23	0.25	—	1.73	5.4	1.428	8.4
72	W728M35-SK	SK	7.218	7.16	7.56	DF-1	2.625	0.438	1.9375	0.23	0.25	—	1.73	6.2	1.428	9.1
80	W808M35-SF	SF	8.02	7.961	8.38	DF-1	2.938	0.563	2.0625	0.23	0.25	—	1.73	6.9	1.428	15.1
90	W908M35-SF	SF	9.023	8.963	—	D-2	2.938	0.563	2.0625	0.23	0.25	—	1.73	7.625	—	20.7
112	W1128M35-SF	SF	11.229	11.166	—	A-3	2.938	0.563	2.0625	0.23	0.25	—	1.73	9.875	—	18.0
144	W1448M35-E	E	14.447	14.37	—	C-3	3.5	0.893	2.6250	—	0.107	—	1.73	12.875	—	38.0
192	W1928M35-E	E	19.249	19.176	—	C-3	3.5	0.893	2.6250	—	0.107	—	1.73	17.625	—	53.0
8mm Pitch, 60 mm (2.36 in.) Wide Belts (8M-60)																
22	W228M60-MPB	MPB	2.206	2.154	2.562	MPBF-1	1.188	0.619	3.375	—	—	1.625	2.756	—	2.506	2.2
24	W248M60-MPB	MPB	2.406	2.354	2.75	MPBF-1	1.25	0.619	3.375	—	—	1.813	2.756	—	2.506	2.7
26	W268M60-MPB	MPB	2.607	2.554	2.937	MPBF-1	1.375	0.619	3.375	—	—	2	2.756	—	2.506	3.3
28	W288M60-MPB	MPB	2.807	2.755	3.156	MPBF-1	1.5	0.619	3.375	—	—	2.281	2.756	—	2.506	4.4
30	W308M60-MPB	MPB	3.008	2.955	3.344	MPBF-1	1.563	0.619	3.375	—	—	2.468	2.756	—	2.506	5.1
32	W328M60-MPB	MPB	3.208	3.155	3.562	MPBF-1	1.625	0.619	3.375	—	—	2.593	2.756	—	2.506	5.9
34	W348M60-MPB	MPB	3.409	3.355	3.750	MPBF-1	1.688	0.619	3.375	—	—	2.796	2.756	—	2.506	6.6
36	W368M60-MPB	MPB	3.609	3.556	3.937	MPBF-1	1.75	0.619	3.375	—	—	3	2.756	—	2.506	7.8
36	W368M60-2012	2012*	3.609	3.556	3.937	KF-1	2	1.506	1.25	—	—	—	2.756	2.82	2.506	2.3
38	W388M60-MPB	MPB	3.810	3.756	4.156	MPBF-1	1.938	0.619	3.375	—	—	3.188	2.756	—	2.506	8.8
38	W388M60-2012	2012*	3.810	3.756	4.156	KF-1	2	1.506	1.25	—	—	—	2.756	3	2.506	2.8
40	W408M60-MPB	MPB	4.010	3.956	4.344	MPBF-1	2.125	0.619	3.375	—	—	3.813	2.756	—	2.506	9.8
40	W408M60-2012	2012*	4.010	3.956	4.344	WF-1	2	1.506	1.25	—	—	—	2.756	3	2.506	2.3
44	W448M60-2517	2517	4.411	4.357	4.75	WF-1	2.5	0.503	1.75	0.503	—	—	2.756	3.5	2.506	5.4
48	W488M60-2517	2517	4.812	4.757	5.157	WF-1	2.5	0.503	1.75	0.503	—	—	2.756	3.8	2.506	3.2
56	W568M60-3020	3020	5.614	5.558	5.937	WF-1	3	0.378	2	0.378	—	—	2.756	4.6	2.506	6.3
64	W648M60-SF	SF	6.416	6.359	6.750	AF-1	2.938	-0.061	2.063	0.754	0.752	—	2.756	5.4	2.506	9.8
72	W728M60-E	E	7.218	7.160	7.562	AF-1	3.5	—	2.625	0.131	1	—	2.756	6.2	2.506	12.8
80	W808M60-E	E	8.020	7.961	8.375	AF-1	3.5	—	2.625	0.131	1	—	2.756	6.9	2.506	19.3
90	W908M60-E	E	9.023	8.963	—	A-1	3.5	—	2.625	0.131	1	—	2.756	7.625	—	20.7
112	W1128M60-F	F	11.229	11.166	—	C-3	4	0.869	3.625	—	0.256	—	2.756	9.875	—	50.3
144	W1448M60-F	F	14.447	14.37	—	C-3	4	0.869	3.625	—	0.256	—	2.756	12.875	—	73.2
192	W1928M60-F	F	19.249	19.176	—	C-3	4	0.869	3.625	—	0.256	—	2.756	17.625	—	81.3

* Weight Shown is for Sprocket Less Bushing.
• Reverse Mount Only

+ The numbers (1=Solid, 2=Web, 3=Arms) within the "Type" indicates construction, and the letter F indicates the sprocket has flanges.

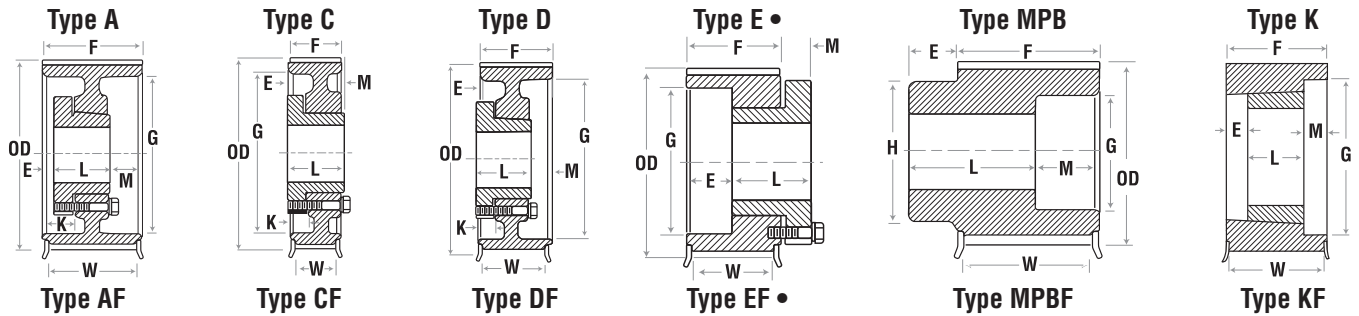

No. of Teeth	Catalog Number	Bore	Pitch	Diameter		Type +	Max Bore	Dimensions								Weight Approx. (lbs.)
				O.D.	Flange			E	L	M	K	H	F	G	W	
14mm Pitch, 20 mm (.79in.) Wide Belts (14M - 20)																
28	W2814M20-SK	SK	4.912	4.805	5.56	DF-1	2.625	0.688	1.938	-0.03	—	—	1.22	2.74	0.908	3.6
29	W2914M20-SK	SK	5.088	4.981	5.56	DF-1	2.625	0.688	1.938	-0.03	—	—	1.22	2.74	0.908	4.0
30	W3014M20-SK	SK	5.263	5.156	6.13	DF-1	2.625	0.688	1.938	-0.03	—	—	1.22	2.74	0.908	4.4
32	W3214M20-SK	SK	5.614	5.507	6.13	DF-1	2.625	0.688	1.938	-0.03	—	—	1.22	2.74	0.908	5.3
34	W3414M20-SK	SK	5.965	5.857	6.5	DF-1	2.625	0.688	1.938	-0.03	—	—	1.22	2.74	0.908	6.2
36	W3614M20-SF	SF	6.316	6.208	6.81	CF-1	2.938	0.813	2.063	-0.03	—	—	1.22	3.05	0.908	5.7
38	W3814M20-SF	SF	6.667	6.559	7.16	CF-1	2.938	0.813	2.063	-0.03	—	—	1.22	3.05	0.908	6.5
40	W4014M20-SF	SF	7.018	6.91	7.5	CF-1	2.938	0.813	2.063	-0.03	—	—	1.22	3.05	0.908	7.6
44	W4414M20-E	E	7.72	7.611	8.22	CF-1	3.5	1	2.625	0.405	—	—	1.22	—	0.908	10.2
48	W4814M20-E	E	8.421	8.312	8.94	CF-1	3.5	1	2.625	0.405	—	—	1.22	—	0.908	13.0
52	W5214M20-E	E	9.123	9.014	9.69	CF-1	3.5	1	2.625	0.405	—	—	1.22	—	0.908	16.7
56	W5614M20-E	E	9.825	9.715	10.38	CF-1	3.5	1	2.625	0.405	—	—	1.22	—	0.908	20.4
60	W6014M20-E	E	10.527	10.417	11.06	CF-1	3.5	1	2.625	0.405	—	—	1.22	—	0.908	23.6
64	W6414M20-E	E	11.229	11.118	11.75	CF-1	3.5	1	2.625	0.405	—	—	1.22	—	0.908	27.1
68	W6814M20-E	E	11.93	11.82	12.5	CF-2	3.5	1	2.625	0.405	—	—	1.22	—	0.908	26.8
72	W7214M20-E	E	12.632	12.521	13.19	CF-2	3.5	1	2.625	0.405	—	—	1.22	—	0.908	29.6
80	W8014M20-E	E	14.036	13.924	14.63	CF-2	3.5	1	2.625	0.405	—	—	1.22	—	0.908	35.3
90	W9014M20-E	E	15.79	15.677	—	C-3	3.5	1.188	2.625	0.218	-0.188	—	1.22	13.563	—	36.6
112	W11214M20-E	E	19.65	19.535	—	C-3	3.5	1.188	2.625	0.218	-0.188	—	1.22	17.375	—	48.0
144	W14414M20-E	E	25.264	25.147	—	C-3	3.5	1.188	2.625	0.218	-0.188	—	1.22	23	—	59.4
168	W16814M20-F	F	29.475	29.355	—	C-3	4	1.563	3.625	0.842	-0.438	—	1.22	27.25	—	98.4
192	W19214M20-J	J	33.686	33.564	—	C-3	4.5	1.938	4.5	1.342	-0.626	—	1.22	31.375	—	147.4
216	W21614M20-J	J	37.896	37.772	—	C-3	4.5	1.938	4.5	1.342	-0.626	—	1.22	35.625	—	155.6
14mm Pitch, 42 mm (1.65 in.) Wide Belts (14M-42)																
28	W2814M42-SK	SK	4.912	4.805	5.56	EF-1 •	2.625	0.837	1.938	0.688	—	—	2.087	2.74	1.774	5.5
29	W2914M42-SK	SK	5.088	4.981	5.56	EF-1 •	2.625	0.837	1.938	0.688	—	—	2.087	2.74	1.774	6.2
30	W3014M42-SK	SK	5.263	5.156	6.13	DF-1	2.625	0.267	1.938	0.416	0.421	—	2.087	3.92	1.774	5.9
32	W3214M42-SK	SK	5.614	5.507	6.13	DF-1	2.625	0.267	1.938	0.416	0.42	—	2.087	3.92	1.774	7.4
34	W3414M42-SF	SF	5.965	5.857	6.5	DF-1	2.938	0.391	2.063	0.415	0.421	—	2.087	3.92	1.774	8.8
36	W3614M42-SF	SF	6.316	6.208	6.81	DF-1	2.938	0.391	2.063	0.415	0.421	—	2.087	4.688	1.774	7.8
38	W3814M42-SF	SF	6.667	6.559	7.16	DF-1	2.938	0.391	2.063	0.415	0.421	—	2.087	4.938	1.774	9.2
40	W4014M42-SF	SF	7.018	6.91	7.5	DF-1	2.938	0.391	2.063	0.415	0.421	—	2.087	5.063	1.774	10.8
44	W4414M42-E	E	7.72	7.611	8.22	DF-1	3.5	0.772	2.625	0.234	0.228	—	2.087	6.125	1.774	13.1
48	W4814M42-E	E	8.421	8.312	8.94	DF-1	3.5	0.772	2.625	0.234	0.228	—	2.087	6.5	1.774	17.2
52	W5214M42-E	E	9.123	9.014	9.69	DF-1	3.5	0.772	2.625	0.234	0.228	—	2.087	7.188	1.774	21.2
56	W5614M42-E	E	9.825	9.715	10.38	DF-1	3.5	0.772	2.625	0.234	0.228	—	2.087	7.875	1.774	25.6
60	W6014M42-E	E	10.527	10.417	11.06	DF-1	3.5	0.772	2.625	0.234	0.228	—	2.087	8.5	1.774	30.3
64	W6414M42-E	E	11.229	11.118	11.75	DF-1	3.5	0.772	2.625	0.234	0.228	—	2.087	9.25	1.774	35.1
68	W6814M42-E	E	11.93	11.82	12.5	DF-2	3.5	0.772	2.625	0.234	0.228	—	2.087	10	1.774	33.7
72	W7214M42-E	E	12.632	12.521	13.19	DF-2	3.5	0.772	2.625	0.234	0.228	—	2.087	10.688	1.774	37.3
80	W8014M42-E	E	14.036	13.924	14.63	DF-2	3.5	0.772	2.625	0.234	0.228	—	2.087	12.125	1.774	44.5
90	W9014M42-F	F	15.79	15.677	—	C-3	4	1.125	3.625	0.413	—	—	2.087	13.563	—	50.8
112	W11214M42-F	F	19.65	19.535	—	C-3	4	1.125	3.625	0.413	—	—	2.087	17.375	—	77.3
144	W14414M42-F	F	25.264	25.147	—	C-3	4	1.125	3.625	0.413	—	—	2.087	23	—	97.4
168	W16814M42-F	F	29.475	29.355	—	C-3	4	1.125	3.625	0.413	—	—	2.087	27.25	—	119.3
192	W19214M42-J	J	33.686	33.564	—	C-3	4.5	1.505	4.5	0.908	—	-0.192	2.087	31.375	—	173.5
216	W21614M42-J	J	37.896	37.772	—	C-3	4.5	1.505	4.5	0.908	—	-0.192	2.087	35.625	—	206.0

* Weight Shown is for Sprocket Less Bushing.
• Reverse Mount Only

+ The numbers (1=Solid, 2=Web, 3=Arms) within the "Type" indicates construction, and the letter F indicates the sprocket has flanges.

High HP HTS® Sprockets 14mm

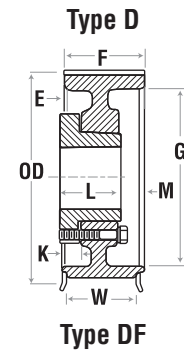
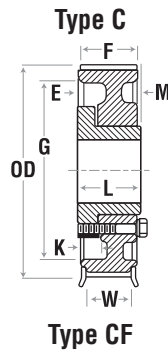
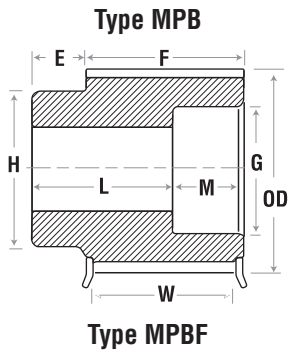

No. of Teeth	Catalog Number	Bore	Pitch	Diameter		Type +	Max Bore	Dimensions								Weight Approx. (lbs.)
				O.D.	Flange			E	L	M	K	H	F	G	W	
14mm Pitch, 65 mm (2.56in.) Wide Belts (14M - 65)																
28	W2814M65-MPB	MPB	4.912	4.805	5.56	MPBF-1	2.313	1	4.032	—	-	3.688	3.032	—	2.719	15.0
29	W2914M65-MPB	MPB	5.088	4.981	5.56	MPBF-1	2.313	1	4.032	—	-	3.688	3.032	—	2.719	16.0
30	W3014M65-MPB	MPB	5.263	5.156	6.13	MPBF-1	2.5	1	4.032	—	-	4.141	3.032	—	2.719	18.0
32	W3214M65-MPB	MPB	5.614	5.507	6.13	MPBF-1	2.5	1	4.032	—	-	4.141	3.032	—	2.719	20.2
34	W3414M65-MPB	MPB	5.965	5.857	6.5	MPBF-1	2.688	1	4.032	—	-	4.484	3.032	—	2.719	23.4
36	W3614M65-MPB	MPB	6.316	6.208	6.81	MPBF-1	3	1	4.032	—	-	4.875	3.032	—	2.719	24.5
36	W3614M65-3030	3030*	6.316	6.208	6.81	MPBF-1	3	0.032	3	—	-	—	3.032	—	2.719	10.8
38	W3814M65-MPB	MPB	6.667	6.559	7.16	MPBF-1	3.250	1	4.032	—	-	5.172	3.032	—	2.719	27.6
38	W3814M65-3030	3030*	6.667	6.559	7.16	MPBF-1	3	0.032	3	—	-	—	3.032	—	2.719	13.4
40	W4014M65-MPB	MPB	7.018	6.910	7.5	MPBF-1	3.438	1	4.032	—	-	5.563	3.032	—	2.719	31.5
40	W4014M65-3535	3535*	7.018	6.910	7.5	CF-1	3.5	0.468	3.5	—	-	6.125	3.032	3.875	2.719	13.2
44	W4414M65-E	E	7.720	7.611	8.22	DF-1	3.5	0.125	2.625	0.532	0.875	—	3.032	6.125	2.719	16.2
48	W4814M65-E	E	8.421	8.312	8.94	DF-1	3.5	0.125	2.625	0.532	0.875	—	3.032	6.5	2.719	21.4
52	W5214M65-E	E	9.123	9.014	9.69	DF-1	3.5	0.125	2.625	0.532	0.875	—	3.032	7.188	2.719	25.9
56	W5614M65-F	F	9.825	9.715	10.38	CF-1	4	0.594	3.625	—	0.531	—	3.032	7.875	2.719	36.3
60	W6014M65-F	F	10.527	10.417	11.06	CF-1	4	0.594	3.625	—	0.531	—	3.032	8.5	2.719	43.5
64	W6414M65-F	F	11.229	11.118	11.75	CF-1	4	0.594	3.625	—	0.531	—	3.032	9.25	2.719	51.0
68	W6814M65-F	F	11.930	11.820	12.5	CF-2	4	0.594	3.625	—	0.531	7.75	3.032	10	2.719	47.9
72	W7214M65-F	F	12.632	12.521	13.19	CF-2	4	0.594	3.625	—	0.531	7.75	3.032	10.688	2.719	52.7
80	W8014M65-F	F	14.036	13.924	14.63	CF-2	4	0.594	3.625	—	0.531	7.75	3.032	12.125	2.719	61.2
90	W9014M65-F	F	15.790	15.677	—	C-3	4	0.594	3.625	—	0.531	7.75	3.032	13.563	—	59.8
112	W11214M65-J	J	19.650	19.535	—	C-3	4.5	1.250	4.5	0.219	0.063	9	3.032	17.375	—	104.2
144	W14414M65-M	M	25.264	25.147	—	C-3	5.5	2.063	6.75	1.657	-0.5	11.375	3.032	23	—	197.3
168	W16814M65-M	M	29.475	29.355	—	C-3	5.5	2.063	6.75	1.657	-0.5	11.375	3.032	27.25	—	207.0
192	W19214M65-M	M	33.686	33.564	—	C-3	5.5	2.063	6.75	1.657	-0.5	11.375	3.032	31.375	—	173.5
216	W21614M65-M	M	37.896	37.772	—	C-3	5.5	2.063	6.75	1.657	-0.5	11.375	3.032	35.625	—	253.0

* Weight Shown is for Sprocket Less Bushing.
• Reverse Mount Only

+ The numbers (1=Solid, 2=Web, 3=Arms) within the "Type" indicates construction, and the letter F indicates the sprocket has flanges.

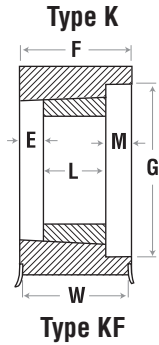
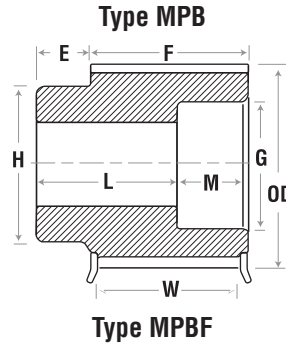
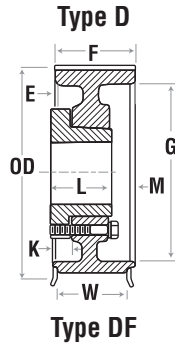
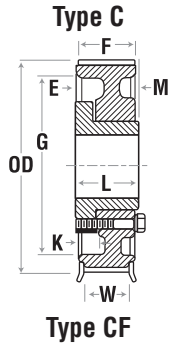

No. of Teeth	Catalog Number	Bore	Pitch	Diameter		Type +	Max Bore	Dimensions								Weight Approx. (lbs.)
				O.D.	Flange			E	L	M	K	H	F	G	W	
14mm Pitch, 90 mm (3.54 in.) Wide Belts (14M-90)																
28	W2814M90-MPB	MPB	4.912	4.805	5.56	MPBF-1	2.313	1	5.055	—	—	3.688	4.055	—	3.743	18.9
29	W2914M90-MPB	MPB	5.088	4.981	5.56	MPBF-1	2.313	1	5.055	—	—	3.688	4.055	—	3.743	20.2
30	W3014M90-MPB	MPB	5.263	5.156	6.13	MPBF-1	2.5	1	5.055	—	—	4.141	4.055	—	3.743	10.9
32	W3214M90-MPB	MPB	5.614	5.507	6.13	MPBF-1	2.5	1	5.055	—	—	4.141	4.055	—	3.743	13.9
34	W3414M90-MPB	MPB	5.965	5.857	6.5	MPBF-1	2.688	1	5.055	—	—	4.484	4.055	—	3.743	16.7
36	W3614M90-MPB	MPB	6.316	6.208	6.81	MPBF-1	3	1	5.055	—	—	4.875	4.055	—	3.743	31.4
38	W3814M90-MPB	MPB	6.667	6.559	7.16	MPBF-1	3.25	1	5.055	—	—	5.172	4.055	4.938	3.743	35.5
40	W4014M90-3535	3535	7.018	6.91	7.5	KF-1	3.5	0.555	3.5	—	—	—	4.055	—	3.743	17.1
44	W4414M90-3535	3535	7.72	7.611	8.22	KF-1	4	0.555	3.5	—	—	—	4.055	—	3.743	24.8
48	W4814M90-4040	4040	8.421	8.312	8.94	KF-1	4	0.055	4	—	—	—	4.055	—	3.743	27.0
52	W5214M90-F	F	9.123	9.014	9.69	DF-1	4	0.347	3.625	0.778	0.778	—	4.055	7.188	3.743	34.7
56	W5614M90-F	F	9.825	9.715	10.38	DF-1	4	0.347	3.625	0.778	0.778	—	4.055	7.875	3.743	36.3
60	W6014M90-F	F	10.527	10.417	11.06	DF-1	4	0.347	3.625	0.778	0.778	—	4.055	8.5	3.743	49.8
64	W6414M90-F	F	11.229	11.118	11.75	DF-1	4	0.347	3.625	0.778	0.778	—	4.055	9.25	3.743	57.6
68	W6814M90-F	F	11.93	11.82	12.5	DF-2	4	0.347	3.625	0.778	0.778	—	4.055	10	3.743	54.8
72	W7214M90-F	F	12.632	12.521	13.19	DF-2	4	0.347	3.625	0.778	0.778	—	4.055	10.688	3.743	60.0
80	W8014M90-J	J	14.036	13.924	14.63	CF-2	4.5	0.375	4.5	0.07	0.938	—	4.055	12.125	3.743	81.5
90	W9014M90-J	J	15.79	15.677	—	C-3	4.5	0.375	4.5	0.07	0.938	—	4.055	13.563	—	77.4
112	W11214M90-J	J	19.65	19.535	—	C-3	4.5	0.375	4.5	0.07	0.938	—	4.055	17.375	—	116.2
144	W14414M90-M	M	25.264	25.147	—	C-3	5.5	1.563	6.75	1.132	—	11.375	4.055	23	—	220.0
168	W16814M90-M	M	29.475	29.355	—	C-3	5.5	1.563	6.75	1.132	—	11.375	4.055	27.25	—	207.0
192	W19214M90-M	M	33.686	33.564	—	C-3	5.5	1.563	6.75	1.132	—	11.375	4.055	31.375	—	268.4
216	W21614M90-M	M	37.896	37.772	—	C-3	5.5	1.563	6.75	1.132	—	11.375	4.055	35.625	—	278.1

* Weight Shown is for Sprocket Less Bushing.
• Reverse Mount Only

+ The numbers (1=Solid, 2=Web, 3=Arms) within the "Type" indicates construction, and the letter F indicates the sprocket has flanges.

High HP HTS® Sprockets 14mm

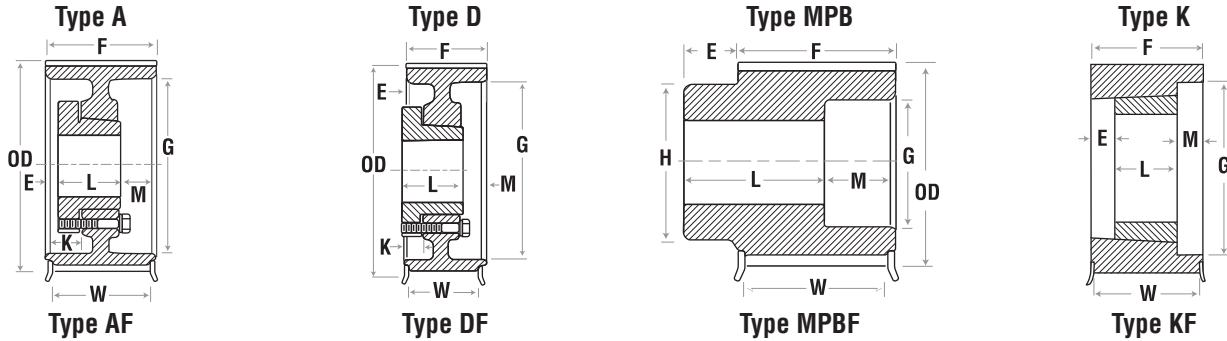

No. of Teeth	Catalog Number	Bore	Pitch	Diameter		Type +	Max Bore	Dimensions							Weight Approx. (lbs.)	
				O.D.	Flange			E	L	M	K	H	F	G		W
14mm Pitch, 120 mm (4.72 in.) Wide Belts (14M-120)																
28	W2814M120-MPB	MPB	4.912	4.805	5.56	MPBF-1	2.313	1	4.986	1.25	—	3.688	5.236	3.125	4.924	22.0
29	W2914M120-MPB	MPB	5.088	4.981	5.56	MPBF-1	2.313	1	4.986	1.25	—	3.688	5.236	3.125	4.924	23.8
30	W3014M120-MPB	MPB	5.263	5.156	6.13	MPBF-1	2.5	1	4.986	1.25	—	4.141	5.236	3.906	4.924	25.1
32	W3214M120-MPB	MPB	5.614	5.507	6.13	MPBF-1	2.5	1	4.986	1.25	—	4.141	5.236	3.906	4.924	29.0
34	W3414M120-MPB	MPB	5.965	5.857	6.5	MPBF-1	2.688	1	4.986	1.25	—	4.484	5.236	4.063	4.924	33.7
36	W3614M120-MPB	MPB	6.316	6.208	6.81	MPBF-1	3	1	4.986	1.25	—	4.875	5.236	4.688	4.924	34.0
38	W3814M120-MPB	MPB	6.667	6.559	7.16	MPBF-1	3.25	1	4.986	1.25	—	5.172	5.236	4.938	4.924	38.4
40	W4014M120-MPB	MPB	7.018	6.91	7.5	MPBF-1	3.438	1	4.986	1.25	—	5.563	5.236	5.063	4.924	43.4
44	W4414M120-3535	3535	7.72	7.611	8.22	KF-1	4	0.868	3.5	0.868	—	—	5.236	5.875	4.924	24.8
48	W4814M120-4040	4040	8.421	8.312	8.94	KF-1	4	0.618	4	0.618	—	—	5.236	6.625	4.924	31.8
52	W5214M120-F	F	9.123	9.014	9.69	AF-1	4	1.125	3.625	1.361	1.375	—	5.236	7.188	4.924	34.7
56	W5614M120-F	F	9.825	9.715	10.38	AF-1	4	1.125	3.625	1.361	1.375	—	5.236	7.875	4.924	48.4
60	W6014M120-F	F	10.527	10.417	11.06	AF-1	4	1.125	3.625	1.361	1.375	—	5.236	8.5	4.924	57.1
64	W6414M120-J	J	11.229	11.118	11.75	DF-1	4.5	0.293	4.5	1.029	1.02	—	5.236	9.25	4.924	69.7
68	W6814M120-J	J	11.93	11.82	12.5	DF-1	4.5	0.293	4.5	1.029	1.02	—	5.236	10	4.924	80.4
72	W7214M120-J	J	12.632	12.521	13.19	DF-1	4.5	0.293	4.5	1.029	1.02	—	5.236	10.688	4.924	92.2
80	W8014M120-J	J	14.036	13.924	14.63	DF-2	4.5	0.293	4.5	1.029	1.02	—	5.236	12.125	4.924	92.5
90	W9014M120-M	M	15.79	15.677	—	C-2	5.5	1.514	6.75	—	0.049	10	5.236	13.563	—	134.5
112	W11214M120-M	M	19.65	19.535	—	C-3	5.5	1.514	6.75	—	0.049	11.375	5.236	17.375	—	193.4
144	W14414M120-M	M	25.264	25.147	—	C-3	5.5	1.514	6.75	—	0.049	11.375	5.236	23	—	234.6
168	W16814M120-M	M	29.475	29.355	—	C-3	5.5	1.514	6.75	—	0.049	11.375	5.236	27.25	—	245.8
192	W19214M120-N	N	33.686	33.564	—	C-3	6	1.875	8.125	1.014	—	12	5.236	31.375	—	381.5

* Weight Shown is for Sprocket Less Bushing.
• Reverse Mount Only

+ The numbers (1=Solid, 2=Web, 3=Arms) within the "Type" indicates construction, and the letter F indicates the sprocket has flanges.